

VS mini J7

Compact General Purpose Inverter

Model: CIMR-J7AZ

200V Class 3-phase 0.1 to 4.0kW

200V Class Single-phase 0.1 to 1.5kW

400V Class 3-phase 0.37 to 4.0kW

QUICK MANUAL



General Precautions

- Some drawings in this manual are shown with protective covers or shields removed in order to show detail with more clarity. Make sure all covers and shields are replaced before operating the product.
- This manual may be modified when necessary because of improvements to the product, modifications, or changes in specifications.
- To order a copy of this manual, or if your copy has been damaged or lost, contact your OMRON YASKAWA Motion Control B. V. (Hereinafter called the OYMC) representatives.
- OYMC is not responsible for any modification of the product made by the user, since that will void the guarantee.

Safety Information

The following conventions are used to indicate precautions in this document. Failure to heed precautions provided in this document can result in serious or possibly even fatal injury or damage to the products or to related equipment and systems.



WARNING

Indicates precautions that, if not heeded, could possibly result in loss of life or serious injury.



CAUTION

Indicates precautions that, if not heeded, could result in relatively serious or minor injury, damage to the product, or faulty operation.

Failure to heed a precaution classified as a caution can result in serious consequences depending on the situation.

Precautions for UL/cUL Marking

- Do not connect or disconnect wiring, or perform signal checks while the power supply is turned ON.
- The Inverter internal capacitor is still charged even after the power supply is turned OFF. To prevent electric shock, disconnect all power before servicing the Inverter, and then wait at least one minute after the power supply is disconnected. Confirm that all indicators are OFF before proceeding.
- Do not perform a withstand voltage test on any part of the Inverter. The Inverter is an electronic device that uses semiconductors, and is thus vulnerable to high voltage.
- Do not remove the Digital Operator or the blank cover unless the power supply is turned OFF. Never touch the printed circuit board (PCB) while the power supply is turned ON.
- This Inverter is not suitable for use on a circuit capable of delivering more than 18,000RMS symmetrical amperes, 250 volts maximum (200V class Inverters) or 480 volts maximum (400 V class Inverters).



CAUTION

Use 75 °C copper wires or equivalent.

Low voltage wires shall be wired with Class I Wiring.

Precautions for CE Markings

- Only basic insulation to meet the requirements of protection class I and overvoltage category II is provided with control circuit terminals.
Additional insulation may be necessary in the end product to conform to CE requirements.
- For 400 V class Inverters, make sure to ground the supply neutral to conform to CE requirements.
- For conformance to EMC directives, refer to section 3 in this document.
For details, refer to the following document.
Document No. EZZ008390 for English version.
- Our products are tested by authorized bodies using the standards listed below.

Product standard: EN61800-3 : 1996

EN61800-3 ; A11 : 2000

Receiving



CAUTION

Do not install or operate any Inverter that is damaged or has missing parts.
Failure to observe this caution may result in injury or equipment damage.

- Verify that the part numbers match your purchase order or packing slip.
- Check the unit for physical damage that may have occurred during shipping.

Warning Display

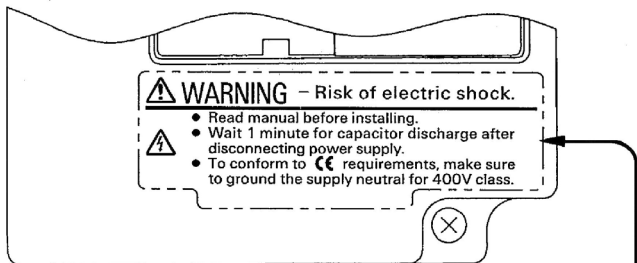

Example of 200V class, 3-phase, 1.5kW inverter



<English>

<French>

<Japanese>

Japanese/French Warning Display

An English warning display is on the front panel of the inverter.

If you need Japanese or French warning display, use the stickers at the back of this manual. Place it over the English warning display.

Checking the Name Plate

Example of 3-phase, 200VAC, 0.1kW (0.13HP)

INVERTER MODEL	→	MODEL: CIMR-J7AZ20P1	SPEC: 20P10	
INPUT SPEC.	→	INPUT: AC3PH 200-230V 50/60Hz 1.1A		
OUTPUT SPEC.	→	OUTPUT: AC3PH 0-230V 0-400Hz 0.8A 0.3kVA		
LOT NO.	→	LOT NO:	MASS: 0.5 kg	← MASS
SERIAL NO.	→	SER NO:	PRG:	← SOFTWARE NO.
		FILE NO: E131457		INSTALLATION CATEGORY II
		IP20  YASKAWA ELECTRIC CORPORATION JAPAN		

Mounting



CAUTION

- Lift the cabinet by the heatsink. When moving the Inverter, never lift it by the plastic case or the terminal covers. Otherwise, the main unit may fall and be damaged.
- Mount the Inverter on nonflammable material (i.e., metal). Failure to observe this caution may result in a fire.
- When mounting Inverters in an enclosure, install a fan or other cooling device to keep the intake air temperature below 122°F (50°C) for IP20 (open chassis type), or below 105°F(40°C) for NEMA1 (TYPE1). Overheating may cause a fire or damage the Inverter.
- The VS mini generates heat. For effective cooling, mount it vertically. Refer to the figure in Mounting Dimensions on section 3.

Wiring



WARNING

- Only begin wiring after verifying that the power supply is turned OFF.
Failure to observe this warning may result in an electric shock or a fire.
- Wiring should be performed only by qualified personnel.
Failure to observe this warning may result in an electric shock or a fire.
- When wiring the emergency stop circuit, check the wiring thoroughly before operation.
Failure to observe this warning may result in injury.
- Always ground the ground terminal according to the local grounding code.
Failure to observe this warning may result in an electric shock or a fire.
- For 400V class, make sure to ground the supply neutral.
Failure to observe this warning may result in an electric shock or a fire.
- If the power supply is turned ON during the FWD(or REV) RUN command is given, the motor will start automatically.
Turn the power supply ON after verifying that the RUN signal is OFF.
Failure to observe this warning may result in injury.
- When the 3-wire sequence is set, do not make the wiring unless the multi-function input terminal parameter is set.
Failure to observe this warning may result in injury.



CAUTION

- Verify that the Inverter rated voltage coincides with the AC power supply voltage.
Failure to observe this caution may result in personal injury or a fire.
- Do not perform a withstand voltage test on the Inverter.
Performing withstand voltage tests may damage semiconductor elements.
- To connect a Braking Resistor, Braking Resistor Unit, or Braking Unit, follow the Procedure described in this manual.
Improper connection may cause a fire.
- Always tighten terminal screws of the main circuit and the control circuits.
Failure to observe this caution may result in a malfunction, damage or a fire.
- Never connect the AC main circuit power supply to output terminals U/T1, V/T2 or W/T3.
The Inverter will be damaged and the guarantee will be voided.
- Do not connect or disconnect wires or connectors while power is applied to the circuits.
Failure to observe this caution may result in injury.
- Do not perform signal checks during operation.
The machine or the Inverter may be damaged.

Precautions for wiring

Wiring the control circuit terminals

Screwdriver blade width

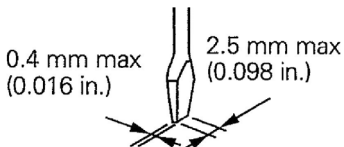
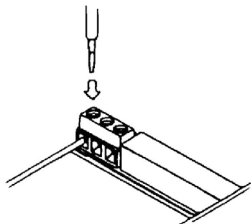

Insert the wire into the lower part of the terminal block and connect it tightly with a screwdriver.

5.5 mm
(0.22 in.)

Wire sheath strip length must be 5.5mm (0.22in).

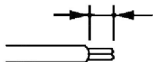

Operation



WARNING

- Only turn ON the input power supply after confirming the Digital Operator or blank cover(optional) are in place. Do not remove the Digital Operator or the covers while current is flowing.
Failure to observe this warning may result in an electric shock.
- Never operate the Digital Operator or DIP the switches with wet hands.
Failure to observe this warning may result in an electric shock.
- Never touch the terminals while current is flowing, even if the Inverter is stopping.
Failure to observe this warning may result in an electric shock.
- When the fault retry function is selected, stand clear of the Inverter or the load.
The Inverter may restart suddenly after stopping.
(Construct the system to ensure safety, even if the Inverter should restart.)
Failure to observe this warning may result in injury.
- When continuous operation after power recovery is selected, stand clear of the Inverter or the load. The Inverter may restart suddenly after stopping.
(Construct the system to ensure safety, even if the Inverter should restart.)
Failure to observe this warning may result in injury.
- The Digital Operator stop button can be disabled by a setting in the Inverter.
Install a separate emergency stop switch.
Failure to observe this warning may result in injury.



WARNING

- If an alarm is reset with the operation signal ON, the Inverter will restart automatically. Reset an alarm only after verifying that the operation signal is OFF. Failure to observe this warning may result in injury.
- When the 3-wire sequence is set, do not make the wiring unless the multi-function input terminal parameter is set. Failure to observe this warning may result in injury.



CAUTION

- Never touch the heatsinks, which can be extremely hot. Failure to observe this caution may result in harmful burns to the body.
- It is easy to change operation speed from low to high. Verify the safe working range of the motor and machine before operation. Failure to observe this caution may result in injury and machine damage.
- Install a holding brake separately if necessary. Failure to observe this caution may result in injury.
- If using an Inverter with an elevator, take safety measures on the elevator to prevent the elevator from dropping. Failure to observe this caution may result in injury.
- Do not perform signal checks during operation. The machine or the Inverter may be damaged.
- All the constants set in the Inverter have been preset at the factory. Do not change the settings unnecessarily. The Inverter may be damaged.

Maintenance and Inspection



WARNING

- Never touch high-voltage terminals on the Inverter.
Failure to observe this warning may result in an electrical shock.
- Disconnect all power before performing maintenance or inspection, and then wait at least one minute after the power supply is disconnected. Confirm that all indicators are OFF before proceeding.
If the indicators are not OFF, the capacitors are still charged and can be dangerous.
- Do not perform withstand voltage test on any part of the VS mini.
The Inverter is an electronic device that uses semiconductors, and is thus vulnerable to high voltage.
- Only authorized personnel should be permitted to perform maintenance, inspections, or parts replacement.
(Remove all metal objects (watches, bracelets, etc.) before starting work.)
Failure to observe these warnings may result in an electric shock.



CAUTION

- The control PCB board employs CMOS ICs. Do not touch the CMOS elements.
They are easily damaged by static electricity.
- Do not connect or disconnect wires, connectors, or the cooling fan while power is applied to the circuit.
Failure to observe this caution may result in injury.

Periodical Inspection

Periodically inspect the inverter as described the following table to prevent accidents and to ensure high performance with high-reliability.

Location to check	Check for	Solution
Terminals, unit mounting screws, etc.	Connection hardware is properly seated and securely tightened.	Properly seat and tighten hardware.
Heatsink	Built up dust, and debris	Blow with dry compressed air: 39.2×10^4 to 58.8×10^4 Pa, 57 to 85 psi (4 to 6kg / cm ²) pressure.
Printed circuit board	Accumulation of conductive material or oil mist	Blow with dry compressed air: 39.2×10^4 to 58.8×10^4 Pa, 57 to 85 psi (4 to 6kg / cm ²) pressure If dust or oil cannot be removed, replace the inverter unit.
Power elements and smoothing capacitor	Abnormal odor or discoloration	Replace the inverter unit.
Cooling fan	Abnormal noise or vibration Cumulative operation time	Replace the cooling fan.

Part Replacement

Inverter's maintenance periods are noted below. Keep them as reference.

Part Replacement Guidelines

Part	Standard Replacement Period	Replacement Method
Cooling fan	2 to 3 years	Replace with new part.
Smoothing capacitor	5 years	Replace with new part. (Determine need by inspection.)
Breaker relays	–	Determine need by inspection.
Fuses	10 years	Replace with new part.
Aluminium capacitors on PCBs	5 years	Replace with new part. (Determine need by inspection.)

Note: Usage conditions are as follows:

- Ambient temperature: Yearly average of 30°C
- Load factor: 80% max.
- Operating rate: 12 hours max. per day

Others



WARNING

- Never modify the product.
Failure to observe this warning can result in an electric shock or injury and will invalidate the guarantee.



CAUTION

- Do not subject the Inverter to halogen gases, such as fluorine, chlorine, bromine, and iodine, at any time even during transportation or installation.
Otherwise, the Inverter can be damaged or interior parts burnt.

VS MINI J7

Quick Start Guide

1. Wiring
2. Control Circuit Terminals
3. Installation
4. Start up and Trial run
5. Quick Parameter List
6. Monitors
7. Faults and Alarms

1. Wiring

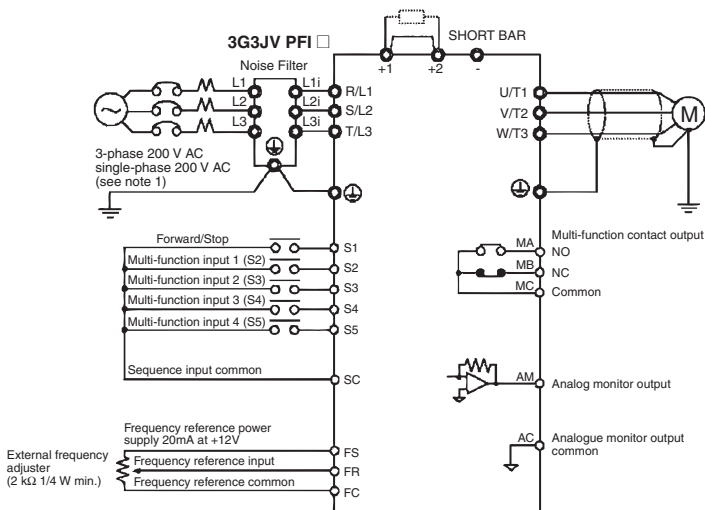

Note 1: Connect single-phase 200 V AC to terminals R/L1 and S/L2 of the J7AZB

Note 2: The braking resistor cannot be connected because no braking transistor is incorporated.

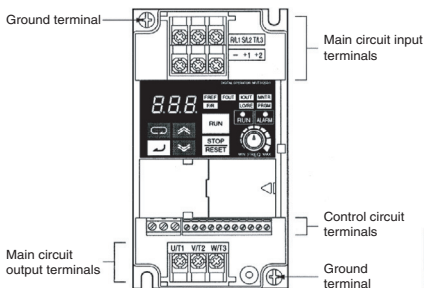

Arrangement of Control Circuit Terminals



2. Control Circuit Terminals

Symbol	Name	Function	Signal Level	
Input	S1	Forward/Stop	Forward at ON/Stops at OFF	Photocoupler 8 mA at 24 V DC ^{*1}
	S2	Multi-function Input 1	Set by parameter n36 (Reverse/Stop) ^{*2}	
	S3	Multi-function Input 2	Set by parameter n37 (External Fault: NO) ^{*2}	
	S4	Multi-function Input 3	Set by parameter n38 (Fault Reset) ^{*2}	
	S5	Multi-function Input 4	Set by parameter n39 (Multi-step reference 1) ^{*2}	
	SC	Sequence Input Common	Common for S1 through S5	
	FS	Frequency Reference Power Supply	DC power supply for frequency reference use	20 mA at 12 V DC
	FR	Frequency Reference Input	Input terminal for frequency reference use	0 to 10 V DC (20 kΩ)
	FC	Frequency Reference Common	Common for frequency reference use	4 to 20 mA 0 to 20 mA
Output	MA	Multi-function output: NO	Set by parameter n40 (during running) ^{*2}	Relay output 1 A max. at 30 V DC and 250 V AC
	MB	Multi-function output: NC		
	MC	Multi-function output Common	Common for MA and MB use	
	AM	Analogue Monitor output	Set by parameter n44 (Output frequency) ^{*2}	12 mA max. at 0 to 10 V DC
	AC	Analogue Monitor output Common	Common for AM use	

*1 NPN is the setting for these terminals. No external power supply is required. Refer to connections shown below

*2 Functions in parentheses are default settings.

Selecting Input Method

Switches SW7 and SW8, both of which are located above the control circuit terminals, are used for input method selection.

Remove the front cover and optional cover to use these switches.

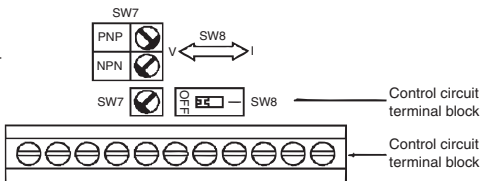

Selecting Sequence Input Method

By using SW7, NPN or PNP input can be selected as shown below

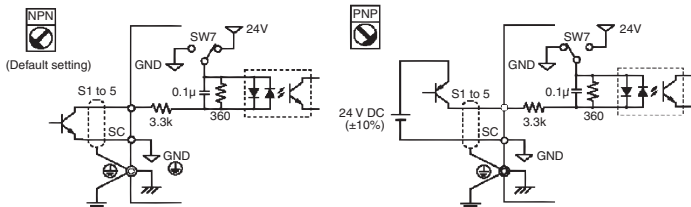

3. Installation

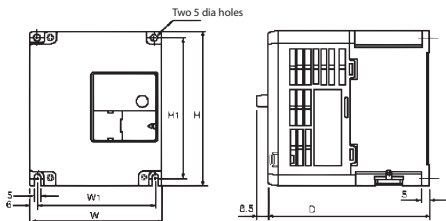

Rated Voltage	Model J7AZ	Dimensions (mm)					Supply Recommendations	
		W	H	D	W1	H1	MCCB (A)	Wire (mm ²)
Three Phase 200 V AC	20P1	68	128	70	56	118	5	2
	20P2	68	128	70	56	118	5	2
	20P4	68	128	102	56	118	5	2
	20P7	68	128	122	56	118	10	2
	21P5	108	128	129	96	118	20	2
	22P2	108	128	154	96	118	20	3.5
Single Phase 200 V AC	24P0	140	128	161	128	118	30	5.5
	B0P1	68	128	70	56	118	5	2
	B0P2	68	128	70	56	118	5	2
	B0P4	68	128	112	56	118	10	2
	B0P7	108	128	129	96	118	20	3.5
	B1P5	108	128	154	96	118	20	5.5
Three Phase 400 V AC	40P2	108	128	81	96	118	5	2
	40P4	108	128	99	96	118	5	2
	40P7	108	128	129	96	118	5	2
	41P5	108	128	154	96	118	10	2
	42P2	108	128	154	96	118	10	2
	43P0	140	128	161	128	118	20	2
44P0	140	128	161	128	118	20	2	

Noise Filter Specifications

Model J7AZ	Filter 3G3JV-	Dimensions						
		W	L	H	Y	X	d	
20P1	PFI2010-SE	82	194	50	92	181	5.3	
20P2								
20P4								
20P7								
21P5	PFI2020-SE	111	169	50	91	156	5.3	
22P2								
24P0	PFI2030-SE	144	174	50	120	161	5.3	
B0P1	PFI1010-SE	71	169	45	51	156	5.3	
B0P2								
B0P4								
B0P7	PFI1020-SE	111	169	50	91	156	5.3	
B1P5								

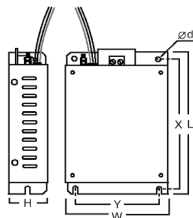

Model	Filter	Dimensions					
		W	L	H	Y	X	d
40P2	PFI3005-SE	111	169	50	91	156	5.3
40P4							
40P7							
41P5							
42P2	PFI3020-SE	144	174	50	120	161	5.3
43P0							
44P0							

Installation of noise filter and J7

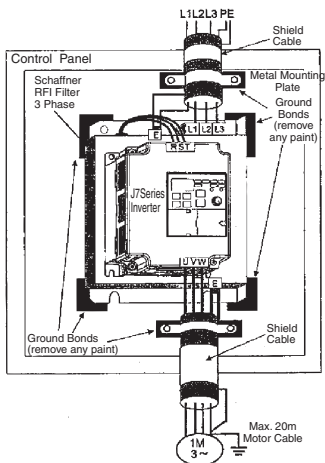

CIMR-J7□□□□20P1 to 24P0
 CIMR-J7□□□□40P2 to 44P0

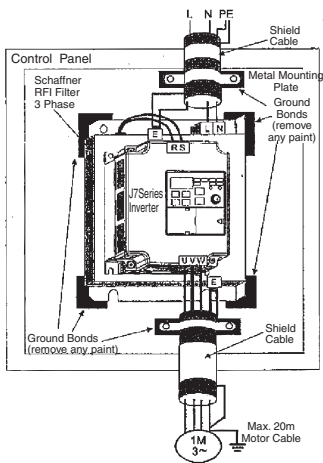

CIMR-J7□□□□B0P1 to B4P0



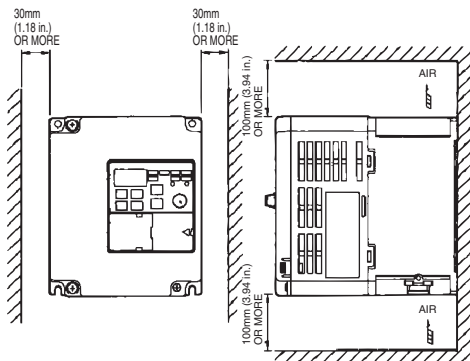





Mounting Dimensions



4. Start up and Trial run



Appearance	Name	Function
	Data display	Displays relevant data items, such as frequency reference, output frequency and parameter set values.
	FREQ adjuster	Sets the frequency reference within a range between 0Hz and the maximum frequency.
	P/REF indicator	The frequency reference can be monitored or set while this indicator is lit.
	F/OUT indicator	The output frequency of the Inverter can be monitored or set while this indicator is lit.
	I/OUT indicator	The output current of the inverter this indicator is lit.
	MNTR indicator	The values set in U01 through U10 are monitored while this indicator is lit.
	F/R indicator	The direction of rotation can be selected while this indicator is lit when operating the Inverter with the RUN Key.

Appearance	Name	Function
	LO/RE indicator	The operation of the Inverter through the Digital Operator or according to the set parameters is selectable while this indicator is lit. Note: The status of this indicator can be only monitored while the Inverter is in operation. Any RUN command input is ignored while this indicator is lit.
	PRGM indicator	The parameter in n01 through to n79 can be set or monitored while this indicator is lit. Note: While the Inverter is in operation, the parameter can be only monitored and only some parameters can be changed. Any RUN command input is ignored while this indicator is lit.
	Mode Key	Switches the setting and monitor item indicators in sequence. Parameter being set will be cancelled if this key is pressed before entering the setting.
	Increment Key	Increases multi-function monitor numbers, parameter numbers and parameter set values.
	Decrement Key	Decreases multi-function monitor numbers, parameter numbers and parameter set values.
	Enter Key	Enters multi-function monitor numbers, parameter numbers and internal data values after they are set or changed.
	RUN Key	Starts the Inverter running when the 3G3JV is in operation with the Digital Operator.
	STP/RESET Key	Stops the Inverter unless parameter n06 is not set to disable the STOP Key.

The following seven steps describe the recommended minimum operations to allow the J7 to control a connected motor in typical configuration, to allow simple operation in the quickest time:

Step 1 – initial checks

1-1 Checkpoints before connecting the power supply.

Check that the power supply is as of the correct voltage.

CIMR-J7AZ2□□□: Three phase 200 to 230VAC

CIMR-J7AZB□□□: Single phase 200 to 240VAC (Wire R/L1 and S/L2)

CIMR-J7AZ4□□□: Three phase 380 to 460VAC

1-2 Make sure that the motor output terminals (U/T1, V/T2, W/T3) are connected to the motor.

1-3 Ensure that the control circuit terminals and the control device are wired correctly.

1-4 Make sure that all control terminals are turned off.

1-5 Set the motor to no-load status (i.e. not connected to the mechanical system)

Step 2 – Connecting the power supply and check the display status

2-1 After conducting the checks in step-1, connect the power supply.

2-2 If the display is normal when the power is connected it will read as follows;

RUN indicator: flashes

ALARM indicator: off





Setting/monitor indicators: FREF, FOUT or IOUT is lit.

Data display: displays the corresponding data for the indicator that is lit.

When fault has occurred, the details of the fault will be displayed. In that case, refer to user's manual and take necessary action.

Step 3 – Initializing parameters





To initialize the drive parameters to factory defaults, set parameter n01 = 8. This will set the J7 to accept start/stop commands in what is termed “2-wire control”, i.e. 1 wire for a motor forward/stop command, and 1 wire for a motor reverse/stop command.

Key Sequence	Indicator	Display example	Explanation
	FREF	00	Power On
	PRGM	n01	Press the Mode Key repeatedly until the PRGM indicator is lit.
	PRGM	1	Press the Enter Key. The data of n01 will be displayed.
	PRGM	8	Use the Increment or Decrement Key to set n01 to 8. The display will flash.
	PRGM	8	Press the Enter Key so that the set value will be entered and the data display will be lit.
In approximately 1s.	PRGM	n01	The parameter number will be displayed.

Step 4 – Set the motor rated current

This parameter is used for the electronic thermal function for motor overload detection (OL1). By correctly setting this, the J7 will protect an overloaded motor from burning out.

Read the rated current (in amps) on the motor nameplate, and enter this into parameter n32. The example to the below shows entering a value of 1.8Amps.

Key Sequence	Indicator	Display example	Explanation
	PRGM	n01	Displays the parameter number
	PRGM	n32	Use the Increment or Decrement Key until n32 is displayed.
	PRGM	1.9	Press the Enter Key. The data of n32 will be displayed.
	PRGM	1.8	Use the Increment or Decrement Key to set the rated motor current. The display will flash.
	PRGM	1.8	Press the Enter Key so that the set value will be entered and the data display will be lit.
In approximately 1s.	PRGM	n32	The parameter number will be displayed.

Step 5 – Set the motor rated frequency

This is the maximum frequency the motor can run and allows the J7 to properly control the motor. Read the rated frequency (in Hz) on the motor nameplate, and enter this into parameters n09 and n11.

Step 6 – Set the operation command

This is the method for motor run and stop commands (i.e. how the inverter will start and stop the motor). The two basic operations are for the RUN and STOP/RESET keys on the Digital Operator, or for one of multi-function inputs through the control circuit terminals.

To set the operation command, enter the appropriate value into parameter n02:

0 = RUN and STOP/RESET keys on the Digital Operator are enabled.

1 = Multi-function inputs through the control circuit terminals.

The diagram to the below shows how to connect a switch to start/stop the motor in the forward direction in "2-wire control". Set parameter n02=1. To enable a separate switch for reverse rotation on control terminal S2, set parameter n36=2 (this is actually the factory default setting for n36).

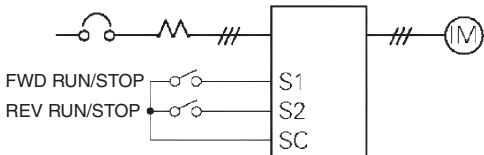

Step 7 – Set the frequency reference

This is the method for selecting the source for the motor speed command. The factory default is for the potentiometer on the digital Operator (FREF adjuster), in which case no setting is required.

Frequency reference can also come from an external potentiometer, an analog output from a PLC, or up to 8 pre-programmed speeds held in the inverter and selected via the multi-function inputs.

For example, to accept frequency reference from an external potentiometer, or a 0-10V analog out from a PLC, set parameter n03=2.

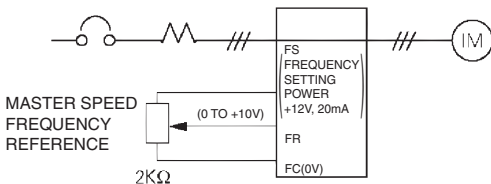

5. Quick Parameter List*1

Parameter No.	Description	Range	Default
n01	Parameter access: 0: Limited parameter access 1: Full parameter access 8: Factory parameter initialise	0 to 9	1
n02	Run command selection: 0: Digital operator 1: Control circuit terminal 2: Communication (option)	0 to 2	0
n03	Frequency reference selection: 0: Digital operator (potentiometer) 1: Frequency reference 1 (n21) 2: Control circuit terminal (0 to 10V) 3: Control circuit terminal (4 to 20mA) 4: Control circuit terminal (0 to 20mA) 6: Communication (option)	0 to 4, 6	0
n09	Maximum output frequency	50 to 400Hz	
n10	Maximum output voltage	1 to 255V (200V class) 1 to 510V (400V class)	200 (200V class) 400 (400V class)
n11	Maximum voltage output frequency	50 to 400Hz	
n16	Acceleration time 1	0.0 to 999sec	10sec
n17	Deceleration time 2	0.0 to 999sec	10sec
n21	Frequency reference 1	0.0 to 400Hz	50Hz
n22 - n28	Frequency reference 2 - 8	0.0 to 400Hz	0Hz
n32	Motor rated current	Depending on model	0 to 120% of inverter rated output current
n36 - n39	Multi-function input (S2 -S5)	0 to 35	--
n40	Multi-function output (MA-MB-MC)	0 to 18	1
n44	Multi-function analog output (AM-AC): 0: Output frequency (10V/Max. freq.) 1: Output current (10V/Inverter rated current)	0,1	0
n46	Carrier frequency	1 to 4 (2.5 - 10kHz) 7 to 9 (Proportional to output freq.)	Depending on model
n52	DC injection braking current	0 to 100%	50%
n53	DC injection braking at stop	0 to 100%	50%
n54	DC injection braking at start	0 to 100%	50%
n55	Stall prevention during deceleration: 0: Enabled 1: Disabled	0,1	0

Multi-function Inputs		Multi-function Outputs	
Value ¹	Function	Value ¹	Function
2	Reverse/Stop	0	Fault Output
3	External Fault (NO)	1	During Run
4	External Fault (NC)	2	Frequency agree
5	Fault reset	6	Overtorque being monitored (NO)
6	Multi-step speed reference 1	12	RUN mode
7	Multi-step speed reference 2	13	Inverter ready

*1 Refer to user's manual for complete list

Multi-function Inputs		Multi-function Outputs	
Value*1	Function	Value*1	Function
8	Multi-step speed reference 3	15	Undervoltage in progress
10	Inching Command	Analogue Output Functionsts	
12	External base block (NO)	Value*1	Function
13	External Base block (NC)	0	Output frequency
17	Local/Remote selection	1	Output current

*1 Refer to user's manual for full set value

Example of Parameter Settings

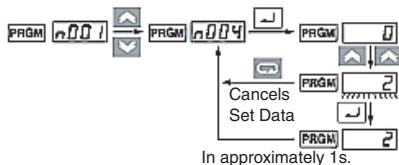

Key Sequence	Indicator	Display example	Explanation
	PRGM	00	Power On
	PRGM	n01	Press the Mode Key repeatedly until the PRGM indicator is lit.
	PRGM	n03	Use the Increment or Decrement Key to set the parameter number.
	PRGM	0	Press the Enter Key. The data of the selected parameter number will be displayed.
	PRGM	2	Use the Increment or Decrement Key to set the data. At that time, the display will flash.
	PRGM	2	Press the Enter Key so that the set value will be entered and the data display will be lit (see note 1)
In approximately 1s.	PRGM	n03	The parameter number will be displayed.















Note 1: To cancel the set value, press the Mode Key instead, The parameter number will be displayed.

2: There are parameters that cannot be changed while the Inverter is in operation. Refer to the list of parameters. When attempting to change such parameters, the data display will not change by pressing the Increment or Decrement Key.

6. Monitors

The Vs mini J7 allows you to monitor various conditions, such as output current and status of multi-function inputs.

This monitoring is performed via the “U” parameters.

Key Sequence	Indicator	Display example	Explanation
			Power On
			Press the Mode Key repeatedly until the MNTR indicator is lit. U01 will be displayed.
			Use the Increment or Decrement Key to select the monitor item to be displayed..
			Press the Enter Key so that the data of the selected monitor item will be displayed.
			The monitor number display will appear again by pressing the mode key.

Constant No.	Name		Description
U01	Frequency Reference (FREF)	Hz	Frequency reference can be monitored. (Same as FREF)
U02	Output frequency (FOUT)	Hz	Output frequency can be monitored. (Same as FOUT)
U03	Output Current (IOUT)	A	Output current can be monitored. (Same as IOUT)
U04	Output Voltage	V	Output voltage can be monitored
U05	DC Voltage	V	Main circuit DC voltage can be monitored
U06	Input Terminal Status	--	Input terminal status of control circuit terminals can be monitored
U07	Output Terminal Status	--	Output terminal status of control circuit terminals can be monitored
U09	Fault History	--	Last four fault history is displayed
U10	Software No.	--	Software No. can be checked
U15	Data Reception Error	--	Contents of MEMOBUS communication data reception error can be checked. (contents of transmission register No. 003DH are the same)

Input/Output terminal status

Input Terminal Status

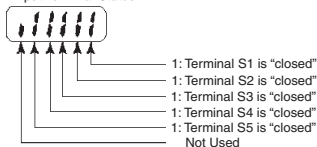

Output Terminal Status

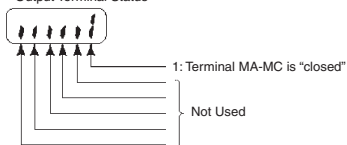

7. Faults and Alarms

Fault Display	Fault name and meaning	Possible cause and remedy
OC	Overcurrent Output current is higher than 250% of inverter rated current.	Check output for short circuit or ground fault. The Load is too large, reduce it or use larger Inverter. Check motor FLA rating compared to inverter and V/F setting.
OV	Overvoltage DC bus voltage has exceeded detection level.	Load inertia is too large and the motor is regenerating. Increase deceleration time (n020 or n022). Connect an external braking resistor and set n092 to 1. Check braking resistor and wiring.
uV1	Main circuit undervoltage DC bus voltage is below detection level.	Check mains power supply voltage and connections. Check correct supply for Inverter being used. Monitor for mains dips or interruptions.
OH	Unit overheated Temperature inside the inverter has exceeded 110°C.	Refer to manual for installation guidelines and recommendations. Check cooling fan (if fitted). Check V/F characteristic ore reduce Carrier frequency.
OL1	Motor overload The inverter is protecting the motor from overload based on an internal IT calculation using n036 setting.	Check and reduce the load. Check V/F characteristic (V_{max} and F_{max}). Increase the running speed of the motor. Increase acceleration/deceleration times.
EF ¹	External fault An external fault has been input.	Check your control terminal wiring. A multi-functional digital input has been set to 3 or 4. Run signal must be removed before this can be reset.
SER (flashing)	Sequence error Sequence input when inverter running.	Inverter must be stopped when Local/Remote switching attempted. Inverter must be stopped when Comms/Remote switching attempted
bb (flashing)	External baseblock An external baseblock command has been input.	Check your control terminal wiring. A multi-functional digital input has been set to 12 or 13.
EF (flashing)	Sequence error has occurred	Forward and reverse run signal have been applied simultaneously.

*1 Refer to user's manual for full fault code listings

VS MINI J7

Kurzanleitung

1. Anschlussplan
2. Steuerklemmen
3. Installation
4. Inbetriebnahme und Testlauf
5. Parameterübersicht
6. Überwachungsanzeige
7. Fehler und Alarme

1. Anschlussplan

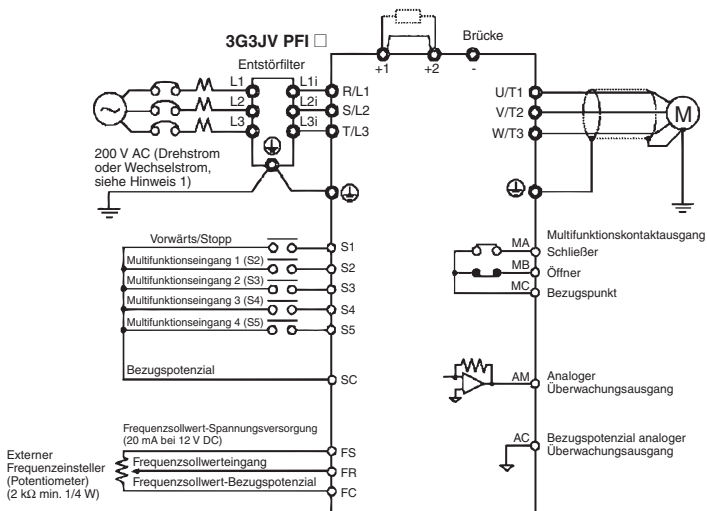

Hinweis 1: 200 V Wechselspannung: Anschluss an die Klemmen R/L1 und S/L2.

Hinweis 2: Der Frequenzrichter verfügt über keinen Bremstransistor, daher kann kein Bremswiderstand angeschlossen werden.

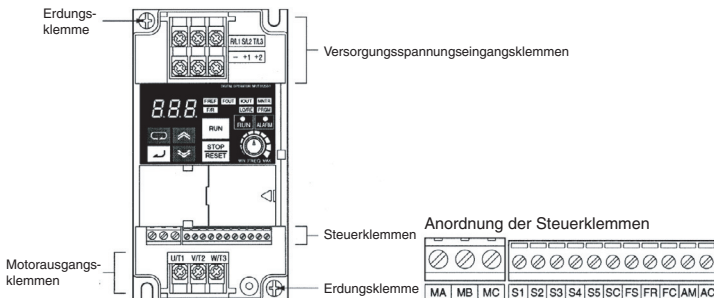

2. Steuerklemmen

Symbol	Bezeichnung	Funktion	Spezifikation	
Eingänge	S1	Vorwärts/Stop	EIN: Vorwärtslauf / AUS: Stopp	Optokoppler (8 mA bei 24 V DC ¹)
	S2	Multifunktionseingang 1	Bestimmt durch Parameter n36 (Rückwärtslauf/Stop) ²	
	S3	Multifunktionseingang 2	Bestimmt durch Parameter n37 (Externer Fehler, Schließer) ²	
	S4	Multifunktionseingang 3	Bestimmt durch Parameter n38 (Fehlerrücksetzung) ²	
	S5	Multifunktionseingang 4	Bestimmt durch Parameter n39 (Multistep-Sollwert 1) ²	
	SC	Bezugspotenzial Multifunktionseingänge	Gemeinsames Bezugspotenzial für die Eingänge S1 bis S5	
	FS	Frequenzsollwert-Spannungsversorgung	DC-Spannungsversorgung für die Einstellung des Frequenzsollwerts	
FR	Frequenzsollwert-Eingang	Eingangsklemme für die Einstellung des Frequenzsollwerts	0 bis 10 V DC (20 kΩ)	
FC	Bezugspotenzial Frequenzsollwert	Bezugspotenzial für die Einstellung des Frequenzsollwerts	4 bis 20 mA 0 bis 20 mA	
Ausgänge	MA	Multifunktionsausgang: Schließer	Bestimmt durch Parameter n40 (während des Betriebs) ²	Relaisausgang (max. 1 A bei 30 V DC bzw. 250 V AC)
	MB	Multifunktionsausgang: Öffner		
	MC	Multifunktionsausgang-Bezugspunkt	Bezugspunkt für MA und MB	
	AM	Analoger Überwachungsausgang	Bestimmt durch Parameter n44 (Ausgangsfrequenz) ²	0 bis 10 V DC, max. 12 mA
	AC	Bezugspotenzial analoger Überwachungsausgang	Bezugspotenzial für die Klemme AM	

*1 Werkseinstellung: NPN-Spannungseingänge. Keine externe Spannungsversorgung erforderlich (siehe nachstehende Anschlussdiagramme)

*2 Bei den Funktionsangaben in Klammern handelt es sich um die Standardeinstellungen.

Auswahl der Eingangspolarität

Mithilfe der Schalter SW7 und SW8 oberhalb des Steuerklemmenblocks kann die Eingangspolarität und die Art des Eingangs (Strom- oder Spannungseingang) umgeschaltet werden.

Diese Schalter befinden sich hinter der Frontabdeckung.

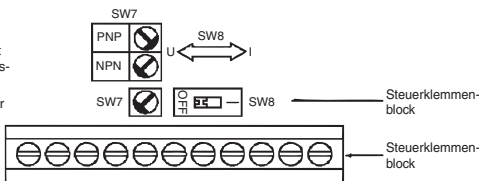

Auswahl der Eingangspolarität

Mithilfe des Schalters SW7 kann die Eingangspolarität wie dargestellt zwischen NPN und PNP umgeschaltet werden.

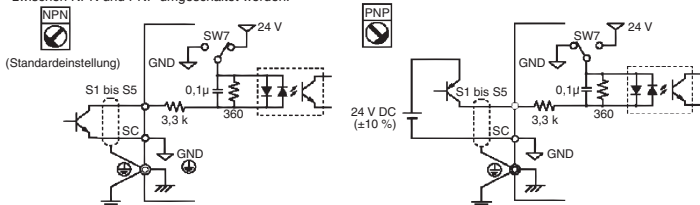

3. Installation

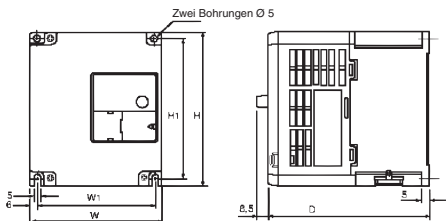

Nennspannung	Modell JAZ	Abmessungen (mm)					Zuleitungen	
		B	H	T	B1	H1	Leistungsschalter (A)	Draht (mm ²)
Drehstrom 200 V AC	20P1	68	128	70	56	118	5	2
	20P2	68	128	70	56	118	5	2
	20P4	68	128	102	56	118	5	2
	20P7	68	128	122	56	118	10	2
	21P5	108	128	129	96	118	20	2
	22P2	108	128	154	96	118	20	3,5
	24P0	140	128	161	128	118	30	5,5
Wechselstrom 200 V AC	B0P1	68	128	70	56	118	5	2
	B0P2	68	128	70	56	118	5	2
	B0P4	68	128	112	56	118	10	2
	B0P7	108	128	129	96	118	20	3,5
	B1P5	108	128	154	96	118	20	5,5
	40P2	108	128	81	96	118	5	2
Drehstrom 400 V AC	40P4	108	128	99	96	118	5	2
	40P7	108	128	129	96	118	5	2
	41P5	108	128	154	96	118	10	2
	42P2	108	128	154	96	118	10	2
	43P0	140	128	161	128	118	20	2
	44P0	140	128	161	128	118	20	2

Entstörfilter

Modell JAZ	Filter 3G3JV-	Abmessungen					
		B	L	H	Y	X	d
20P1	PFI2010-SE	82	194	50	92	181	5,3
20P2							
20P4							
20P7							
21P5	PFI2020-SE	111	169	50	91	156	5,3
22P2							
24P0	PFI2030-SE	144	174	50	120	161	5,3
B0P1	PFI1010-SE	71	169	45	51	156	5,3
B0P2							
B0P4							
B0P7	PFI1020-SE	111	169	50	91	156	5,3
B1P5							

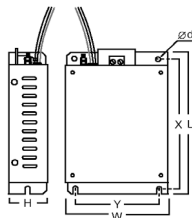

Modell J7AZ	Filter 3G3JV-	Abmessungen					
		B	L	H	Y	X	d
40P2	PFI3005-SE	111	169	50	91	156	5,3
40P4							
40P7							
41P5							
42P2	PFI3010-SE	111	169	50	91	156	5,3
43P0							
44P0							

Installation von Entstörfilter und Frequenzumrichter

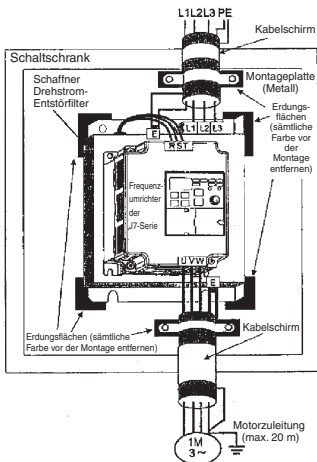

CIMR-J7□□□□20P1 bis 24P0
 CIMR-J7□□□□40P2 bis 44P0

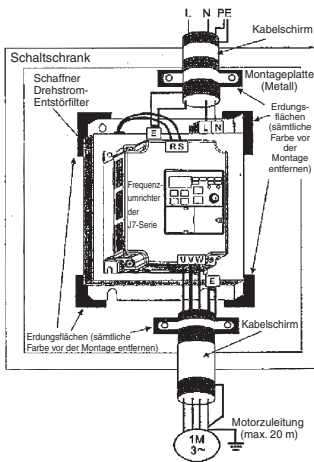

CIMR-J7□□□□B0P1 bis B4P0



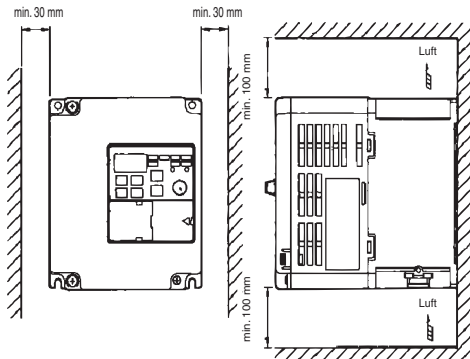





Einbauabmessungen



4. Inbetriebnahme und Testlauf



Anzeige	Bezeichnung	Funktion
	Datenanzeige	Anzeige relevanter Daten wie Frequenzsollwert, Ausgangsfrequenz und eingestellte Parameterwerte.
	FREQ-Einsteller	Einstellung des Frequenzsollwerts auf einen zwischen 0 Hz und der Maximalfrequenz liegenden Wert.
	FREF-Anzeige	Wenn diese Anzeige leuchtet, wird der Frequenzsollwert angezeigt und kann eingestellt werden.
	FOUT-Anzeige	Wenn diese Anzeige leuchtet, wird die Ausgangsfrequenz des Frequenzumrichters angezeigt und kann eingestellt werden.
	IOUT-Anzeige	Wenn diese Anzeige leuchtet, wird der Ausgangsstrom des Frequenzumrichters angezeigt.
	MNTR-Anzeige	Wenn diese Anzeige leuchtet, können die durch U01 bis U10 bestimmten Betriebsparameterwerte angezeigt werden.
	F/R-Anzeige	Wenn diese Anzeige leuchtet, kann die Drehrichtung ausgewählt werden, die bei Aktivierung des Frequenzumrichters mit der RUN-Taste verwendet wird.

Anzeige	Bezeichnung	Funktion
	LO/RE-Anzeige	Wenn diese Anzeige leuchtet, kann ausgewählt werden, ob der Betrieb des Frequenzumrichters über die digitale Bedienkonsole oder gemäß der eingestellten Parameter erfolgt. Hinweis: Der Status dieser Einstellung kann nur bei laufendem Frequenzumrichterbetrieb angezeigt werden. RUN-Befehle werden ignoriert, solange diese Anzeige leuchtet.
	PRGM-Anzeige	Wenn diese Anzeige leuchtet, können die Parameter n01 bis n79 angezeigt und eingestellt werden. Hinweis: Während des Frequenzumrichterbetriebs können die Parameter lediglich angezeigt werden. Nicht alle Parameter können eingestellt werden. RUN-Befehle werden ignoriert, solange diese Anzeige leuchtet.
	Betriebsarten-Taste	Wechselt der Reihe nach durch die o. a. Anzeige- und Einstellungsanzeigen. Ungespeicherte Änderungen an Parametereinstellungen werden verworfen, wenn diese Taste gedrückt wird.
	Erhöhen-Taste	Erhöhen von Parameternummern (Anzeige und Einstellung) und Parameter-Einstellungen.
	Verringern-Taste	Verringern von Parameternummern (Anzeige und Einstellung) und Parameter-Einstellungen.
	Eingabetaste	Übernahme von Parameternummern (Anzeige und Einstellung), Übernahme geänderter Parametereinstellungen.
	RUN-Taste	Starten des Frequenzumrichters, sofern diese Taste nicht durch eine entsprechende Parametereinstellung gesperrt ist.
	STOP/RESET-Taste	Stoppen des Frequenzumrichters, sofern die STOP-Taste nicht durch eine entsprechende Einstellung des Parameters n06 deaktiviert wurde.

Die folgenden sieben Schritte beschreiben die Vorgehensweise zur Inbetriebnahme des Frequenzumrichters, um in kürzester Zeit den einfachen Betrieb eines Motors in einer typischen Konfiguration zu ermöglichen:

Schritt 1 – Grundüberprüfungen

- 1-1 Vor dem Anschluss der Versorgungsspannung durchzuführende Überprüfungen.
Kontrollieren Sie die Versorgungsspannung:
CIMR-J7AZ2□□□: Drehstrom 200 bis 230 V AC
CIMR-J7AZB□□□: Wechselstrom 200 bis 240 V AC (Anschluss an R/L1 und S/L2)
CIMR-J7AZ4□□□: Drehstrom 380 bis 460 V AC
- 1-2 Kontrollieren Sie den korrekten Anschluss des Motors an die Motorausgangsklemmen (U/T1, V/T2, W/T3).
- 1-3 Kontrollieren Sie den korrekten Anschluss des Steuerschaltkreises an die Steuerklemmen.
- 1-4 Stellen Sie sicher, dass alle Steuerklemmen auf AUS geschaltet sind.
- 1-5 Trennen Sie den Motor von der Last.

Schritt 2 – Anschließen der Spannungsversorgung und Überprüfen des Anzeigestatus

- 2-1 Schließen Sie nach Durchführen der Überprüfungen in Schritt 1 die Spannungsversorgung an den Frequenzumrichter an.
- 2-2 Treten beim Anschließen und Einschalten der Spannungsversorgung keine Fehler auf, zeigt die Anzeige das folgende Verhalten:

RUN-Anzeige: blinkt.

ALARM-Anzeige: aus

















Sonstige Anzeigen (Einstellung/Anzeige): FREF, FOUT oder IOUT leuchtet.

Datenanzeige: zeigt die entsprechenden Daten (Frequenzsollwert, Ausgangsfrequenz oder Ausgangsstrom) an.

Trat beim Einschalten der Versorgungsspannung ein Fehler auf, werden die Details des Fehlers angezeigt. Konsultieren Sie in diesem Fall die Bedienungsanleitung, und ergreifen Sie die erforderlichen Maßnahmen.

Schritt 3 – Initialisieren der Parameter

















Zum Zurücksetzen der Frequenzrichter-Parameter auf die Werkseinstellungen setzen Sie den Parameter n01 auf 8. In dieser Einstellung erfolgt die Ansteuerung des Frequenzrichters im so genannten Zweidrahtbetrieb, d. h. ein Multifunktionseingang („Draht“) fungiert als Vorwärts/Stop-Befehl, ein weiterer als Rückwärts/Stop-Befehl.

Tastenfolge	Anzeige	Datenanzeige (Beispiel)	Erläuterung
			Spannung EIN
			Drücken Sie wiederholt die Mode Key, bis die PRGM-Anzeige leuchtet.
			Drücken Sie die Eingabetaste. Nun wird die aktuelle Einstellung des Parameters n01 angezeigt.
			Stellen Sie mithilfe der Erhöhen- oder Verringern-Taste den Wert 8 ein. Dabei blinkt die Datenanzeige.
			Drücken Sie die Eingabetaste, damit der geänderte Wert übernommen wird. Anschließend wird der Wert nicht mehr blinkend, sondern konstant leuchtend angezeigt.
Nach etwa einer Sekunde			Die Parameternummer wird wieder angezeigt.

Schritt 4 – Einstellung des Motornennstroms

Dieser Parameter regelt das Verhalten des elektronischen Thermorelais für den Motorüberlastschutz (OL1). Bei korrekter Einstellung dieses Parameters verhindert der Frequenzrichter das Durchbrennen des Motors bei Überlastung.

Lesen Sie den auf dem Typenschild des Motors angegebenen Nennstrom (A) ab, und stellen Sie den Parameter n32 auf diesen Wert. Das folgende Beispiel zeigt die Einstellung des Werts 1,8 A.

Tastenfolge	Anzeige	Datenanzeige (Beispiel)	Erläuterung
			Anzeige der Parameternummer.
			Stellen Sie mithilfe der Erhöhen- oder Verringern-Taste den Parameter n32 ein.
			Drücken Sie die Eingabetaste. Nun wird die aktuelle Einstellung des Parameters n32 angezeigt.
			Stellen Sie mithilfe der Erhöhen- oder Verringern-Taste den Motornennstrom ein. Dabei blinkt die Datenanzeige.
			Drücken Sie die Eingabetaste, damit der geänderte Wert übernommen wird. Anschließend wird der Wert nicht mehr blinkend, sondern konstant leuchtend angezeigt.
Nach etwa einer Sekunde			Die Parameternummer wird wieder angezeigt.

Schritt 5 – Einstellung der Motornennfrequenz

Die Motornennfrequenz gibt die maximale Betriebsfrequenz des Motors an. Der Frequenzumrichter benötigt diese Angabe, um den Motor ordnungsgemäß ansteuern zu können. Lesen Sie die auf dem Typenschild des Motors angegebene Nennfrequenz (Hz) ab, und stellen Sie die Parameter n09 und n11 auf diesen Wert.

Schritt 6 – Einstellen der Befehlsquelle

Legen Sie fest, wie die Start- und Stopfbefehle gegeben werden. Dies kann wahlweise über die RUN- und die STOP/RESET-Taste oder über entsprechende Signale an Multifunktionseingängen erfolgen.

Die Einstellung der Befehlsquelle erfolgt durch Setzen des Parameters n02 auf den entsprechenden Wert:

- 0: Die RUN- und die STOP/RESET-Taste sind aktiviert.
- 1: Start- und Stopfbefehle werden über Steuerklemmen gegeben.

Das nachstehende Diagramm zeigt den Anschluss eines Schalters zum Starten/Stoppen des Motors im Vorwärtslauf im so genannten Zweidrahtbetrieb. Dazu muss der Parameter n02 auf 1 gesetzt sein. Um mit einem weiteren Schalter an Steuerklemme S2 den Rückwärtslauf zu aktivieren, muss zusätzlich der Parameter n36 auf 2 gesetzt sein (Standardeinstellung).

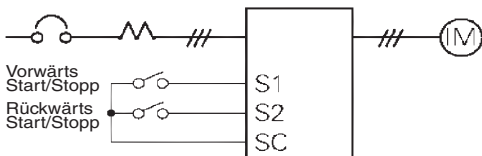

Schritt 7 – Einstellen des Frequenzsollwerts

Legen Sie fest, wie die Drehzahl des Motors eingestellt wird. Standardmäßig erfolgt dies mithilfe des **FREQ**-Einstellers, bei dessen Verwendung keine weiteren Einstellungen erforderlich sind.

Der Frequenzsollwert kann auch mittels eines externen Potenziometers oder eines analogen SPS-Ausgangs geregelt oder auf einen von acht im Frequenzumrichter vorprogrammierten und vermittels der Multifunktionseingänge ausgewählten Werten gesetzt werden.

Um beispielsweise den Frequenzsollwert mittels eines externen Potenziometers oder eines analogen SPS-Ausgangs zu regeln, muss der Parameter n03 auf 2 gesetzt werden.

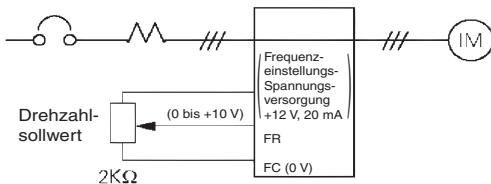

5. Parameterübersicht*1

Parameter-Nr.	Beschreibung	Bereich	Standardeinstellung
n01	Parameterschutz: 0: Beschränkter Zugriff auf die Parameter 1: Vollständiger Zugriff auf die Parameter 8: Zurücksetzen der Parameter auf die Werkseinstellungen	0 bis 9	1
n02	Befehlsquelle: 0: Bedientasten 1: Steuerklemmen 2: Kommunikation (Option)	0 bis 2	0
n03	Frequenzsollwertquelle: 0: FREQ-Einsteller 1: Frequenzsollwert 1 (n21) 2: Steuerklemme (0 bis 10 V) 3: Steuerklemme (4 bis 20 mA) 4: Steuerklemme (0 bis 20 mA) 6: Kommunikation (Option)	0 bis 4, 6	0
n09	Maximale Ausgangsfrequenz	50 bis 400 Hz	
n10	Maximale Ausgangsspannung	1 bis 255V (200-V-Klasse) 1 bis 510V (400-V-Klasse)	200 V (200-V-Klasse) 400 V (400-V-Klasse)
n11	Maximale Ausgangsfrequenz	50 bis 400 Hz	
n16	Beschleunigungszeit 1	0,0 bis 999 s	10 s
n17	Verzögerungszeit 2	0,0 bis 999 s	10 s
n21	Frequenzsollwert 1	0,0 bis 400 Hz	50 Hz
n22 bis n28	Frequenzsollwert 2 bis 8	0,0 bis 400 Hz	0 Hz
n32	Motornennstrom	Modellabhängig	0 bis 120 % des Frequenzumrichterennstroms
n36 bis n39	Multifunktionsgänge S2 bis S5	0 bis 35	--
n40	Multifunktionsgänge (MA/MB)	0 bis 18	1
n44	Analoger Multifunktionsausgang (AM): 0: Ausgangsfrequenz (10 V = Maximalfrequenz) 1: Ausgangsstrom (10 V = Frequenzumrichterennstrom)	0,1	0
n46	Trägerfrequenz	1 bis 4 (2,5 bis 10 kHz) 7 bis 9 (proportional zur Ausgangsfrequenz)	Modellabhängig
n52	DC-Bremsstrom	0 bis 100 %	50 %
n53	DC-Bremsstrom beim Stopp	0 bis 100 %	50 %
n54	DC-Bremsstrom beim Start	0 bis 100 %	50 %
n55	Blockierschutz bei Verzögerung: 0: Aktiviert 1: Deaktiviert	0,1	0

Multifunktionsgänge		Multifunktionsgänge	
Einstellung*1	Funktion	Einstellung*1	Funktion
2	Rückwärts/Stopp	0	Fehlerausgang
3	Externer Fehler (Schließer)	1	In Betrieb
4	Externer Fehler (Offner)	2	Frequenzübereinstimmung
5	Fehlerrücksetzung	6	Drehmomentüberschreitung wird überwacht (Schließer)
6	Multistep-Drehzahlsollwert 1	12	RUN-Betriebsart

*1 Eine vollständige Liste finden Sie in der Bedienungsanleitung.

Multifunktionseingänge		Multifunktionsausgänge	
Einstellung ^{*1}	Funktion	Einstellung ^{*1}	Funktion
7	Multistep-Drehzahlsollwert 2	13	Frequenzrichter bereit
8	Multistep-Drehzahlsollwert 3	15	Unterspannung
10	Tippbetrieb	Analoger Überwachungsausgang	
12	Externe Endstufensperre (Schließer)	Einstellung ^{*1}	Funktion
13	Externe Endstufensperre (Öffner)	0	Ausgangsfrequenz
17	Umschaltung Lokal / Dezentral	1	Ausgangsstrom

*1 Eine vollständige Liste finden Sie in der Bedienungsanleitung.

Parametereinstellungen (Beispiel)

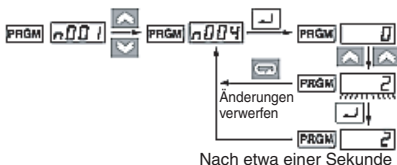

Tasten-Folge	Anzeige	Datenanzeige (Beispiel)	Erläuterung
	FRFZ	00	Spannung EIN
	PRGM	n01	Drücken Sie wiederholt die Mode Key, bis die PRGM-Anzeige leuchtet.
	PRGM	n03	Stellen Sie mithilfe der Erhöhen- oder Verringern-Taste die Parameternummer ein.
	PRGM	0	Drücken Sie die Eingabetaste. Nun wird die aktuelle Einstellung des ausgewählten Parameters angezeigt.
	PRGM	2	Stellen Sie mithilfe der Erhöhen- oder Verringern-Taste den gewünschten Wert ein. Dabei blinkt die Datenanzeige.
	PRGM	2	Drücken Sie die Eingabetaste, um den geänderten Wert zu übernehmen. Anschließend wird der Wert nicht mehr blinkend, sondern konstant leuchtend angezeigt (siehe Hinweis 1).
Nach etwa einer Sekunde	PRGM	n03	Die Parameternummer wird wieder angezeigt.















Hinweis 1: Wenn Sie die geänderte Parametereinstellung nicht übernehmen, sondern verwerfen möchten, drücken Sie einfach stattdessen die Betriebsartentaste. Anschließend wird wieder die Parameternummer angezeigt.

- 2:** Bestimmte Parameter können während des laufenden Frequenzrichterbetriebs nicht geändert werden (siehe Parameterliste). Wenn Sie versuchen, einen dieser Parameter zu ändern, zeigt die Datenanzeige beim Drücken der Erhöhen- oder Verringern-Taste keine Änderung.

6. Überwachungsanzeige

Der Frequenzrichter VS Mini J7 ermöglicht die kontinuierliche Anzeige bestimmter Betriebsparameter (z. B. Ausgangsstrom oder Status der Multifunktionseingänge).

Diese Überwachung erfolgt mithilfe der „U“-Parameter.

Tastenfolge	Anzeige	Datenanzeige (Beispiel)	Erläuterung
			Spannung EIN
			Drücken Sie wiederholt die Betriebsartentaste, bis die MNTR-Anzeige leuchtet. Nun wird U01 angezeigt.
			Stellen Sie mithilfe der Erhöhen- oder Verringern-Taste den anzuzeigenden/zu überwachenden Betriebsparameter ein.
			Drücken Sie die Eingabetaste. Nun wird der Wert des ausgewählten Betriebsparameters kontinuierlich angezeigt.
			Durch erneutes Drücken der Betriebsartentaste wird wieder die Nummer des angezeigten Betriebsparameters angezeigt.

Einstellung	Bezeichnung		Beschreibung
U01	Frequenzsollwert (FREF)	Hz	Anzeige des Frequenzsollwerts (entspricht FREF)
U02	Ausgangsfrequenz (FOUT)	Hz	Anzeige der Ausgangsfrequenz (entspricht FOUT)
U03	Ausgangsstrom (IOUT)	A	Anzeige des Ausgangsstroms (entspricht IOUT)
U04	Ausgangsspannung	V	Anzeige der Ausgangsspannung
U05	Zwischenkreisspannung	V	Anzeige der Zwischenkreisspannung
U06	Eingangsklemmenstatus	--	Anzeige des Status der Steuerklemmen
U07	Ausgangsklemmenstatus	--	Anzeige des Status der Ausgangsklemmen
U09	Fehlerspeicher	--	Anzeige der letzten vier Fehler
U10	Software-Nummer	--	Anzeige der Software-Nummer
U15	Datenempfangsfehler	--	Anzeige des Inhalt des MEMOBUS-Kommunikations-Datenempfangsfehler-Registers (entspricht dem Übertragungsregisters 003Dh)

Eingangs-/Ausgangsklemmenstatus

Eingangsklemmenstatus

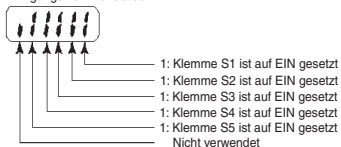

Ausgangsklemmenstatus

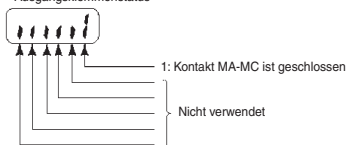

7. Fehler und Alarme

Fehleranzeige	Bezeichnung und Bedeutung	Mögliche Ursachen und Abhilfemaßnahmen
OC	Überstrom Der Ausgangsstrom beträgt mehr als 250 % des Frequenzumrichter-nennstroms.	Ausgang auf Kurz- oder Erdschluss überprüfen. Die Last ist zu groß. Last reduzieren oder leistungsfähigeren Frequenzumrichter einsetzen. Maximalen Motorstrom in Hinsicht auf maximalen Frequenzumrichter-ausgangsstrom und U/f-Einstellung überprüfen.
OV	Überspannung Die Zwischenkreisspannung übersteigt den Überspannungs-Erkennungspegel.	Beim generatorischen Betrieb des Motors ist die Massenträgheit der Last zu groß. Verzögerungszeit (n020 oder n022) vergrößern. Externe Brems Einheit anschließen und n092 auf 1 setzen. Bremswiderstand und Verdrahtung überprüfen.
UV1	Zwischenkreisunterspannung Die Zwischenkreisspannung unterschreitet den Unterspannungs-Erkennungspegel.	Versorgungsspannung und Anschlüsse überprüfen. Eignung der Versorgungsspannung für den Frequenzumrichter überprüfen. Versorgungsspannung auf Spannungseinbrüche und -unterbrechungen überwachen.
OH	Überhitzung Die Temperatur im Inneren des Frequenzumrichters hat 110 °C überschritten.	Richtlinien und Empfehlungen der Bedienungsanleitung beachten. Kühllüfter (sofern vorhanden) überprüfen. U/f-Kennlinie überprüfen oder Trägerfrequenz reduzieren.
OL1	Motorüberlastung Der Frequenzumrichter schützt den Motor mittels interner, auf dem Wert des Parameters n036 basierender Berechnungen vor Überlastung.	Last überprüfen und ggf. reduzieren. U/f-Kennlinie (U_{max} und f_{max}) überprüfen. Motordrehzahl erhöhen. Beschleunigungs-/Verzögerungszeiten erhöhen.
EF ¹	Externer Fehler Dem Frequenzumrichter wurde ein externer Fehler signalisiert.	Verdrahtung des Steuerschaltkreises überprüfen. Einer der Parameter für die Funktion der Multifunktionseingänge wurde auf 3 oder 4 gesetzt. Dieser Fehlerzustand kann erst nach Aufheben des RUN-Signals gelöscht werden.
SER (blinkend)	Sequenzfehler Sequenzeingabe bei laufendem Frequenzumrichter.	Umschaltung zwischen lokaler und dezentraler Steuerung kann nur bei angehaltenem Frequenzumrichter erfolgen. Umschaltung zwischen Kommunikations- und dezentraler Steuerung kann nur bei angehaltenem Frequenzumrichter erfolgen.
bb (blinkend)	Externe Endstufensperre Ein externer Endstufensperrebefehl wurde gegeben.	Verdrahtung des Steuerschaltkreises überprüfen. Einer der Parameter für die Funktion der Multifunktionseingänge wurde auf 12 oder 13 gesetzt.
EF (blinkend)	Sequenzfehler	Vorwärts- und Rückwärtslaufsignal wurden gleichzeitig angelegt.

¹ Eine vollständige Fehlercode-Liste finden Sie in der Bedienungsanleitung.

VARIADOR DE VELOCIDAD J7

Guía rápida

1. Cableado
2. Terminales del circuito de control
3. Instalación
4. Inicio y prueba de funcionamiento
5. Lista rápida de parámetros
6. Monitorización
7. Fallos y alarmas

1. Cableado

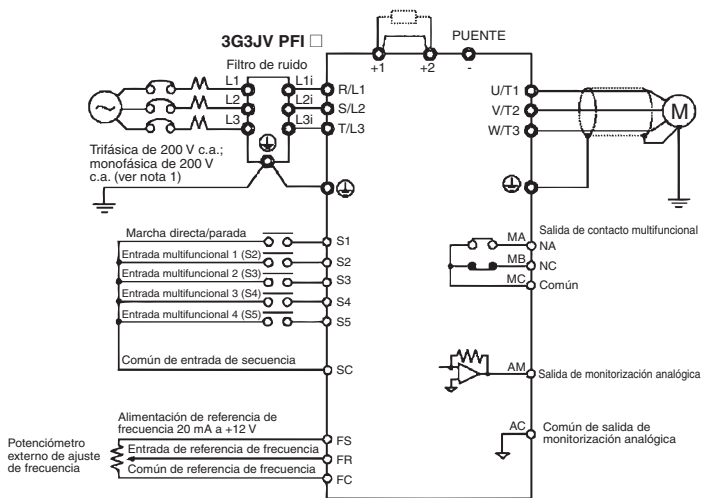

Nota 1: Conecte la alimentación monofásica de 200 V c.a. a los terminales R/L1 y S/L2 del J7AZB

Nota 2: La resistencia de freno no puede conectarse porque no hay incorporado un transistor de freno.

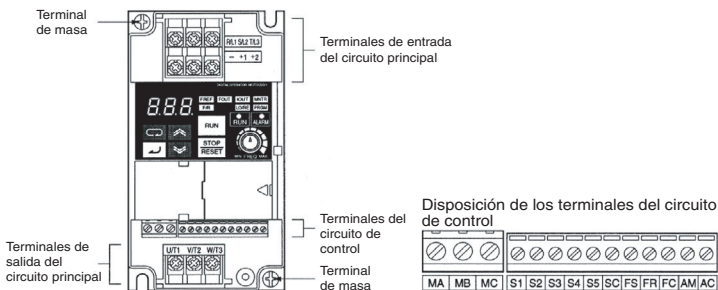

2. Terminales del circuito de control

Símbolo	Nombre	Función	Nivel de la señal	
Entrada	S1	Marcha directa/Parada	Marcha directa: ON, Parada: OFF	Fotoacoplador de 8 mA a 24 V c.c. ^{*1}
	S2	Entrada multifuncional 1	Configurada mediante el parámetro n36 (Inversa/Parada) ^{*2}	
	S3	Entrada multifuncional 2	Configurada mediante el parámetro n37 (Fallo externo: NA) ^{*2}	
	S4	Entrada multifuncional 3	Configurada mediante el parámetro n38 (Reset de fallo) ^{*2}	
	S5	Entrada multifuncional 4	Configurada mediante el parámetro n39 (Referencia de multivelocidad 1) ^{*2}	
	SC	Común de entrada de secuencia	Común para S1 hasta S5	
	FS	Alimentación eléctrica de referencia de frecuencia	Alimentación eléctrica de c.c. para uso de referencia de frecuencia	20 mA a 12 V c.c.
	FR	Entrada de referencia de frecuencia	Terminal de entrada para uso de referencia de frecuencia	0 a 10 V c.c. (20 kΩ)
	FC	Común de referencia de frecuencia	Común para uso de referencia de frecuencia	4 a 20 mA 0 a 20 mA
Salida	MA MB	Salida multifuncional: NA Salida multifuncional: NC	Configurada por el parámetro n40 (durante el funcionamiento) ^{*2}	Salida de relé 1 A máx. a 30 V c.c. y 250 V c.a.
	MC	Común de salida multifuncional	Común para uso de MA y MB	
	AM	Salida de monitorización analógica	Configurada mediante el parámetro n44 (Frecuencia de salida) ^{*2}	12 mA máx. a 0 hasta 10 V c.c.
	AC	Común de salida de monitorización analógica	Común para uso de AM	

*1 La configuración de estos terminales es NPN. No se requiere una fuente de alimentación externa. Consulte las conexiones que se indican a continuación

*2 Las funciones entre paréntesis indican la configuración predeterminada.

Selección del método de entrada

Los interruptores SW7 y SW8, ambos situados sobre los terminales del circuito de control, se utilizan para la selección del método de entrada.

Para utilizar estos interruptores, retire la cubierta delantera y la cubierta opcional.

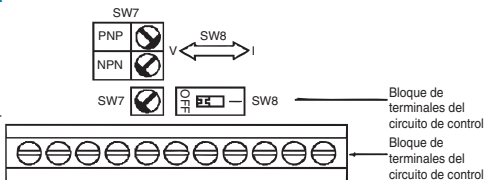

Selección de entrada de secuencia

La entrada puede seleccionarse empleando SW7, NPN o PNP, tal y como se indica a continuación

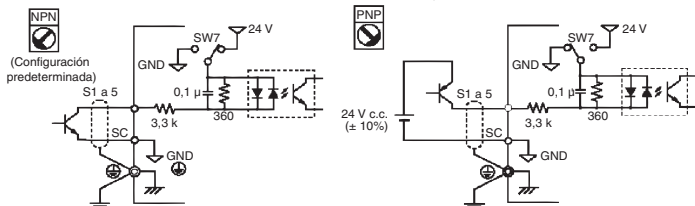

3. Instalación

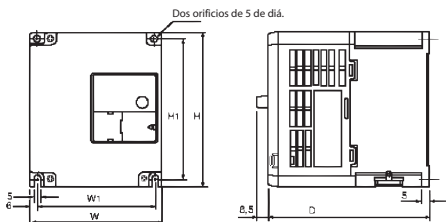

Tensión nominal	Modelo J7AZ	Dimensiones (mm)					Línea y protección recomendada	
		A	H	F	A1	H1	MCCB (A)	Hilo (mm ²)
Trifásica de 200 V c.a.	20P1	68	128	70	56	118	5	2
	20P2	68	128	70	56	118	5	2
	20P4	68	128	102	56	118	5	2
	20P7	68	128	122	56	118	10	2
	21P5	108	128	129	96	118	20	2
	22P2	108	128	154	96	118	20	3.5
	24P0	140	128	161	128	118	30	5.5
Monofásica de 200 V c.a.	B0P1	68	128	70	56	118	5	2
	B0P2	68	128	70	56	118	5	2
	B0P4	68	128	112	56	118	10	2
	B0P7	108	128	129	96	118	20	3.5
	B1P5	108	128	154	96	118	20	5.5
	40P2	108	128	81	96	118	5	2
Trifásica de 400 V c.a.	40P4	108	128	99	96	118	5	2
	40P7	108	128	129	96	118	5	2
	41P5	108	128	154	96	118	10	2
	42P2	108	128	154	96	118	10	2
	43P0	140	128	161	128	118	20	2
	44P0	140	128	161	128	118	20	2

Especificaciones del filtro de ruido

Modelo J7AZ	Filtro 3G3JV-	Dimensiones					
		A	L	H	Y	X	f
20P1	PFI2010-SE	82	194	50	92	181	5,3
20P2							
20P4							
20P7							
21P5	PFI2020-SE	111	169	50	91	156	5,3
22P2							
24P0	PFI2030-SE	144	174	50	120	161	5,3
B0P1	PFI1010-SE	71	169	45	51	156	5,3
B0P2							
B0P4							
B0P7	PFI1020-SE	111	169	50	91	156	5,3
B1P5							

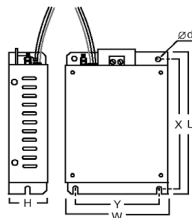

Modelo	Filtro	Dimensiones					
		A	L	H	Y	X	f
40P2	PFI3005-SE	111	169	50	91	156	5,3
40P4							
40P7							
41P5							
42P2	PFI3010-SE	111	169	50	91	156	5,3
43P0							
44P0							

Instalación del filtro de ruido y J7

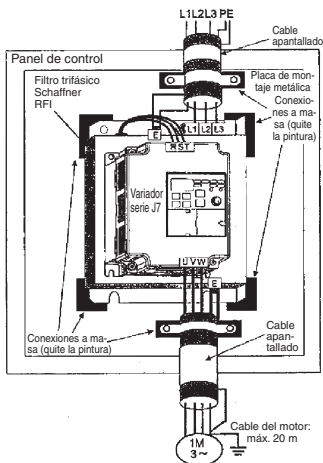

CIMR-J7□□□□20P1 hasta 24P0
 CIMR-J7□□□□40P2 hasta 44P0

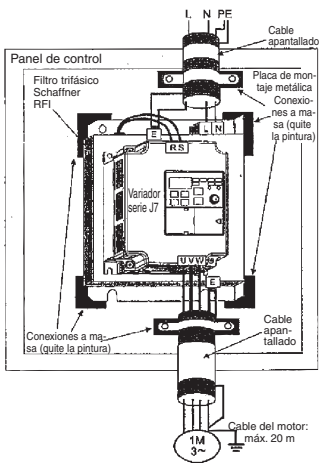

CIMR-J7□□□□B0P1 hasta B4P0



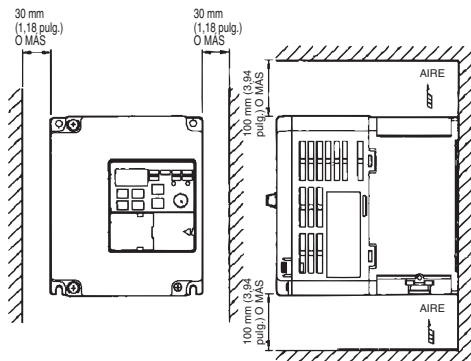





Dimensiones de instalación



4. Inicio y prueba de funcionamiento



Aspecto	Nombre	Función
	Display de datos	Muestra los elementos de datos pertinentes, como referencia de frecuencia, frecuencia de salida y valores seleccionados de parámetro.
	Potenciómetro de ajuste de frecuencia (FREQ)	Selecciona la referencia de frecuencia en un intervalo entre 0 Hz y la frecuencia máxima.
	Indicador de referencia de frecuencia (FREF)	La referencia de frecuencia se puede monitorizar o seleccionar mientras este indicador esté iluminado.
	Indicador de salida de frecuencia (FOUT)	La frecuencia de salida del variador se puede monitorizar o seleccionar mientras este indicador esté iluminado.
	Indicador de salida del variador (IOUT)	La corriente de salida del variador se puede monitorizar mientras este indicador esté iluminado.
	Indicador de monitorización (MNTR)	Mientras este indicador esté iluminado, se monitorizan los valores seleccionados en U01 hasta U10.
	Indicador de directa/inversa (F/R)	La dirección de rotación se puede seleccionar mientras este indicador esté iluminado, cuando el variador esté funcionando con la tecla RUN

Aspecto	Nombre	Función
	Indicador de local/remota (LO/RE)	Mientras este indicador esté iluminado, se puede seleccionar la operación del variador a través del operador digital o según los parámetros seleccionados. Nota: El estado de este indicador sólo puede monitorizarse mientras el variador esté en funcionamiento. Cualquier entrada de comando RUN será ignorada mientras este indicador esté iluminado.
	Indicador PRGM	Los parámetros de n01 hasta n79 pueden seleccionarse o monitorizarse mientras este indicador esté iluminado. Nota: Mientras el variador esté en funcionamiento, los parámetros sólo podrán ser monitorizados, y sólo algunos modificados. Cualquier entrada de comando RUN será ignorada mientras este indicador esté iluminado.
	Tecla Modo	Alterna secuencialmente los indicadores de elemento de selección y monitorización. El parámetro que se esté configurando quedará cancelado si se pulsa esta tecla antes de introducir la selección.
	Tecla Más	Aumenta los números de monitorización multifuncional, los números de parámetros y los valores seleccionados de parámetro.
	Tecla Menos	Disminuye los números de monitorización multifuncional, los números de parámetros y los valores seleccionados de parámetro.
	Tecla Enter	Permite introducir números de monitorización multifuncional, números de parámetro y valores de datos internos después de haber sido seleccionados o modificados.
	Tecla RUN	Pone en marcha el variador cuando el 3G3JV está funcionando con el operador digital
	Tecla STOP/RESET	Detiene el funcionamiento del variador, siempre y cuando el parámetro n06 no esté configurado para inhabilitar la tecla STOP.

Los siete pasos siguiente describen las operaciones mínimas recomendadas que permiten que el J7 controle un motor conectado en una configuración típica, con el objeto de permitir un funcionamiento sencillo en el menor tiempo:

Paso 1 – Comprobaciones iniciales

- 1-1 Comprobaciones a realizar antes de conectar la fuente de alimentación.
Compruebe que la tensión de la fuente de alimentación es la correcta.
CIMR-J7AZ2□□□: Trifásica de 200 a 230 Vc.a.
CIMR-J7AZB□□□: Monofásica de 200 a 240 Vc.a. (hilo R/L1 y S/L2)
CIMR-J7AZ4□□□: Trifásica de 380 a 460 Vc.a.
- 1-2 Asegúrese de que los terminales de salida del motor (U/T1, V/T2, W/T3) estén conectados al motor.
- 1-3 Asegúrese de que los terminales del circuito de control y el dispositivo de control estén cableados correctamente.
- 1-4 Asegúrese de que todos los terminales de control estén desconectados.
- 1-5 Ajuste el motor para funcionar en vacío (es decir, no conectado al sistema mecánico)

Paso 2 – Conexión de la fuente de alimentación y comprobación del estado del display

- 2-1 Una vez realizadas las comprobaciones del paso 1, conecte la fuente de alimentación.

2-2 Si el display es normal al conectar la alimentación, presentará la siguiente información:

indicador RUN: parpadea

indicador ALARM: apagado





Indicadores de selección/monitorización: FREF, FOUT o IOUT iluminado.

Display de datos: muestra los datos correspondientes al indicador iluminado.

En caso de haberse producido un fallo, presentará los detalles del mismo. En tal caso, consulte el manual del usuario y adopte las medidas pertinentes.

Paso 3 – Inicialización de parámetros





Para inicializar los parámetros a los valores predeterminados de fábrica, configure el parámetro n01 = 8. De este modo, el J7 quedará configurado para aceptar comandos de inicio/parada en lo que se denomina "control de 2 hilos". Es decir, un hilo para el comando de marcha directa/parada y el otro para un comando de marcha inversa/parada de un motor.

Secuencia de teclas	Indicador	Display ejemplo	Explicación
	FREF	00	Alimentación ON
	PRGM	n01	Pulse varias veces la tecla Modo hasta que se ilumine el indicador PRGM.
	PRGM	1	Pulse la tecla Enter. De este modo se visualizarán los datos del parámetro n01.
	PRGM	8	Utilice las teclas Más o Menos para configurar el parámetro n01 con el valor 8. El display parpadeará.
	PRGM	8	Pulse la tecla Enter para introducir el valor seleccionado, tras lo cual se iluminará el display de datos.
En aproximadamente 1 s.	PRGM	n01	Se mostrará número de parámetro.

Paso 4 – Configuración de la corriente nominal del motor

Este parámetro se utiliza para la función termoelectrónica de detección de sobrecarga del motor (OL1). Si lo configura correctamente, el J7 impedirá que un motor sobrecargado se quemé.

Lea la corriente nominal (en amperios) en la placa de referencia del motor, y especifique este valor en el parámetro n32. En el siguiente ejemplo se ha especificado un valor de 1,8 amperios.

Secuencia de teclas	Indicador	Display ejemplo	Explicación
	PRGM	n01	Muestra el número del parámetro
	PRGM	n32	Pulse las teclas Más o Menos hasta que aparezca n32.
	PRGM	19	Pulse la tecla Enter. De este modo se visualizarán los datos del parámetro n32.
	PRGM	18	Utilice las teclas Más o Menos para seleccionar la corriente nominal del motor. El display parpadeará.
	PRGM	18	Pulse la tecla Enter para introducir el valor seleccionado, tras lo cual se iluminará el display de datos.
En aproximadamente 1 s.	PRGM	n32	Se mostrará número de parámetro.

Paso 5 – Configuración de la frecuencia nominal del motor

Es la frecuencia máxima a la que puede funcionar el motor, y permite al J7 controlarlo correctamente. Lea la frecuencia nominal (en Hz) en la placa de referencia del motor, y especifique este valor en los parámetros n09 y n11.

Paso 6 – Configuración del comando de operación

Es el método correspondiente a los comandos de funcionamiento y parada del motor (es decir, el modo en que el variador pondrá en marcha y parará el motor). Las dos operaciones básicas corresponden a las teclas RUN y STOP/RESET del operador digital, o bien a una de las entradas multifuncionales de los terminales del circuito de control.

Para seleccionar el comando de operación, especifique el valor adecuado en el parámetro n02:

0 = las teclas RUN y STOP/RESET del operador digital están habilitadas.

1 = Entradas multifuncionales a través de los terminales del circuito de control.

El siguiente diagrama muestra cómo conectar un interruptor para poner en marcha directa/parar el motor, con el "control de 2 hilos". Configure el parámetro n02=1. Para habilitar un interruptor independiente para la rotación inversa en el terminal de control S2, configure el parámetro n36=2 (que es la configuración predeterminada de fábrica del parámetro n36).

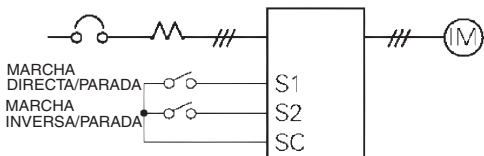

Paso 7 – Configuración de la referencia de frecuencia

Es el método para seleccionar el origen del comando de velocidad del motor. La configuración predeterminada de fábrica es para el potenciómetro del operador digital (potenciómetro de ajuste de frecuencia, FREF), en cuyo caso no será necesaria ninguna configuración.

La referencia de frecuencia también puede proceder de un potenciómetro externo, de la salida analógica de un autómata programable o de hasta 8 velocidades preprogramadas guardadas en el variador y seleccionadas a través de las entradas multifuncionales.

Por ejemplo, para aceptar la referencia de frecuencia de un potenciómetro externo, o bien de la salida analógica de 0-10 V de un autómata programable, configure el parámetro n03=2.

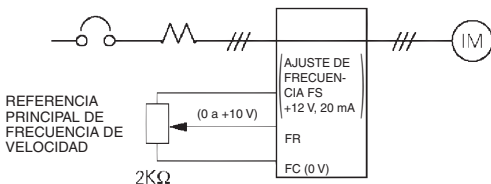

5. Lista rápida de parámetros*1

Nº de parámetro	Descripción	Intervalo	Valor predeterminado
n01	Acceso al parámetro: 0: acceso limitado al parámetro 1: acceso pleno al parámetro 8: inicializar parámetro predeterminado de fábrica	0 a 9	1
n02	Selección del comando Run: 0: operador digital 1: terminal del circuito de control 2: comunicaciones (opcional)	0 a 2	0
n03	Selección de la referencia de frecuencia: 0: operador digital (potenciómetro) 1: referencia de frecuencia 1 (n21) 2: terminal del circuito de control (0 a 10 V) 3: terminal del circuito de control (4 a 20 mA) 4: terminal del circuito de control (0 a 20 mA) 6: comunicaciones (opcional)	0 a 4, 6	0
n09	Frecuencia de salida máxima	50 a 400 Hz	
n10	Tensión máxima de salida	1 a 255 V (categoría 200 V) 1 a 510 V (categoría 400 V)	200 (categoría 200 V) 400 (categoría 400 V)
n11	Frecuencia de salida de tensión máxima	50 a 400 Hz	
n16	Tiempo de aceleración 1	0,0 a 999 seg	10 seg
n17	Tiempo de deceleración 2	0,0 a 999 seg	10 seg
n21	Referencia de frecuencia 1	0,0 a 400 Hz	50 Hz
n22 - n28	Referencia de frecuencia 2 - 8	0,0 a 400 Hz	0 Hz
n32	Corriente nominal del motor	Según el modelo	Del 0 al 120% de la corriente de salida nominal del variador
n36 - n39	Entrada multifuncional (S2 -S5)	0 a 35	--
n40	Salida multifuncional (MA-MB-MC)	0 a 18	1
n44	Salida analógica multifuncional (AM-AC) 0: salida de frecuencia (10 V/frec. máx.) 1: corriente de salida (10 V/corriente nominal del variador)	0,1	0
n46	Frecuencia de portadora	1 a 4 (2,5 - 10 kHz) 7 a 9 (proporcional a la frec. de salida)	Según el modelo
n52	Corriente de freno de inyección de c.c.	0 a 100%	50%
n53	Freno de inyección de c.c. a la parada	0 a 100%	50%
n54	Freno de inyección de c.c. al inicio	0 a 100%	50%
n55	Prevención de bloqueo durante deceleración: 0: habilitada 1: inhabilitada	0,1	0

Entradas multifuncionales		Salidas multifuncionales	
Valor*1	Función	Valor*1	Función
2	Marcha inversa/parada	0	Salida de fallo
3	Fallo externo (NA)	1	Durante Run
4	Fallo externo (NC)	2	Frecuencia alcanzada
5	Reset de fallo	6	Monitorización de sobrepasar (NA)
6	Referencia de multivelocidad 1	12	Modo RUN
7	Referencia de multivelocidad 2	13	Variador preparado

*1 Consulte la lista completa en el manual del usuario

Entradas multifuncionales		Salidas multifuncionales	
Valor ^{*1}	Función	Valor ^{*1}	Función
8	Referencia de multivelocidad 3	15	Infratensión en curso
10	Comando Marcha por impulsos	Ajustes de funciones de salida analógica	
12	Base block externo (NA)	Valor ^{*1}	Función
13	Base block externo (NC)	0	Frecuencia de salida
17	Selección local/remota	1	Corriente de salida

*1 Consulte en el manual del usuario los valores completos

Ejemplo de configuración de parámetros

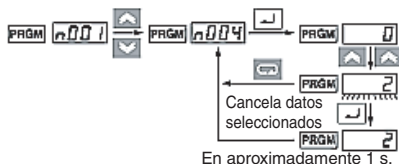

Secuencia de teclas	Indicador	Ejemplo de display	Explicación
	FREF	00	Alimentación ON
	PRGM	n01	Pulse varias veces la tecla Modo hasta que se ilumine el indicador PRGM.
	PRGM	n03	Utilice las teclas Más o Menos para seleccionar el número de parámetro.
	PRGM	0	Pulse la tecla Enter. Podrán verse los datos del número del parámetro seleccionado.
	PRGM	2	Utilice las teclas Más o Menos para configurar los datos. En ese momento, el display parpadeará.
	PRGM	2	Pulse la tecla Enter para introducir el valor seleccionado, tras lo cual se iluminará el display de datos (ver nota 1)
En aproximadamente 1 s.	PRGM	n03	Se mostrará número de parámetro.















Nota 1: Para cancelar el valor seleccionado, pulse la tecla Modo. De este modo se visualizará el número del parámetro.

- 2:** Existen parámetros que no pueden modificarse mientras el variador está en funcionamiento. Consulte la lista de parámetros. Si se intentan modificar dichos parámetros, el display de datos no cambiará al pulsar las teclas Más o Menos.

6. Monitorización

El variador de velocidad J7 permite monitorizar diversas situaciones, como por ejemplo la corriente de salida y el estado de las entradas multifunción.

La monitorización se realiza mediante los parámetros "U".

Secuencia de teclas	Indicador	Ejemplo de display	Explicación
			Alimentación ON
			Pulse varias veces la tecla Modo hasta que se ilumine el indicador MNTR. El display indicará U01.
			Utilice las teclas Más o Menos para seleccionar el elemento monitorizado que desee visualizar.
			Pulse la tecla Enter para visualizar los datos del elemento monitorizado seleccionado.
			El número de monitorización volverá a aparecer pulsando la tecla Modo.

Nº constante	Nombre		Descripción
U01	Referencia de frecuencia (FREF)	Hz	La referencia de frecuencia puede monitorizarse. (Idéntico a FREF)
U02	Frecuencia de salida (FOUT)	Hz	La frecuencia de salida puede monitorizarse. (Idéntico a FOUT)
U03	Corriente de salida (IOUT)	A	La corriente de salida puede monitorizarse. (Idéntico a IOUT)
U04	Tensión de salida	V	La tensión de salida puede monitorizarse.
U05	Tensión de c.c.	V	La tensión de c.c. del circuito principal puede monitorizarse.
U06	Estado de terminal de entrada	--	El estado del terminal de entrada de los terminales del circuito de control puede monitorizarse.
U07	Estado de terminal de salida	--	El estado del terminal de salida de los terminales del circuito de control puede monitorizarse.
U09	Histórico de fallos	--	Muestra los cuatro último fallos del histórico de fallos
U10	Nº de software	--	Es posible verificar el nº de software
U15	Error de recepción de datos	--	Es posible verificar el contenido de errores de recepción de datos de las comunicaciones MEMOBUS. (el contenido del nº de registro de transmisión 003DH es idéntico)

Estado de terminal de entrada/salida

Estado de terminal de entrada

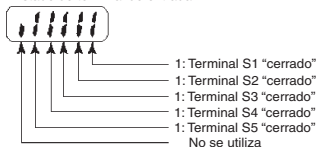

Estado de terminal de salida

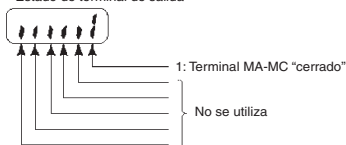

7. Fallos y alarmas

Visualización de fallos	Nombre y significado del fallo	Posible causa y solución
OC	Sobrecorriente La corriente de salida es superior al 250% de la corriente nominal del variador.	Verifique la salida para comprobar que no se haya producido un cortocircuito o un error de puesta a tierra. La carga es demasiado grande: redúzcala o utilice un variador más grande. Compruebe el valor FLÁ (amperaje a plena carga) del motor y compárelo con el ajuste de V/F del variador.
OV	Sobretensión La tensión del bus de c.c. ha excedido del nivel de detección.	La inercia de carga es demasiado grande y el motor está regenerando. Incremente el tiempo de deceleración (n020 ó n022). Conecte una resistencia de freno externa y configure el parámetro n092 a 1. Compruebe la resistencia de freno y el cableado.
uV1	Infratensión del circuito principal La tensión del bus de c.c. está por debajo del nivel de detección.	Compruebe la tensión y las conexiones de la fuente de alimentación de red. Compruebe que la alimentación del variador utilizado sea la correcta. Verifique los interruptores DIP de la fuente de alimentación principal.
OH	Unidad recalentada La temperatura interior del variador supera los 110 °C.	Consulte las directrices y recomendaciones del manual de instalación. Compruebe el ventilador (si procede). Compruebe las características de V/F o reduzca la frecuencia de portadora.
OL1	Sobrecarga del motor El variador protege al motor contra sobrecargas basándose en el cálculo de la temperatura interna mediante la configuración del parámetro n036.	Compruebe la carga y redúzcala. Verifique las características de V/F ($V_{m\acute{a}x}$ y $F_{m\acute{a}x}$). Incremente la velocidad de funcionamiento del motor. Incremente los tiempos de aceleración/deceleración.
EF ¹	Fallo externo Se ha producido un fallo externo.	Compruebe el cableado del terminal de control. Una entrada digital multifuncional ha sido configurada como 3 ó 4. Para poder modificar esta configuración, primero debe cancelarse la señal RUN.
SER (parpadea)	Error de secuencia Entrada de secuencia mientras el variador está funcionando.	Al intentar un cambio entre Local y Remoto, primero debe interrumpirse el funcionamiento del variador. Al intentar un cambio entre Comunicaciones y Remoto, primero debe interrumpirse el funcionamiento del variador.
bb (parpadea)	Base block externo Se ha especificado un comando baseblock externo.	Compruebe el cableado del terminal de control. Una entrada digital multifuncional ha sido configurada como 12 ó 13.
EF (parpadea)	Se ha producido un error de secuencia	Se ha aplicado simultáneamente la señal RUN de directa e inversa.

*1 Consulte en el manual del usuario la lista completa de códigos de fallos

VS MINI J7

Guide de démarrage rapide

1. Câblage
2. Bornes de circuit de contrôle
3. Installation
4. Démarrage et essai
5. Aperçu de la liste des paramètres
6. Moniteurs
7. Erreurs et alarmes

1. Câblage

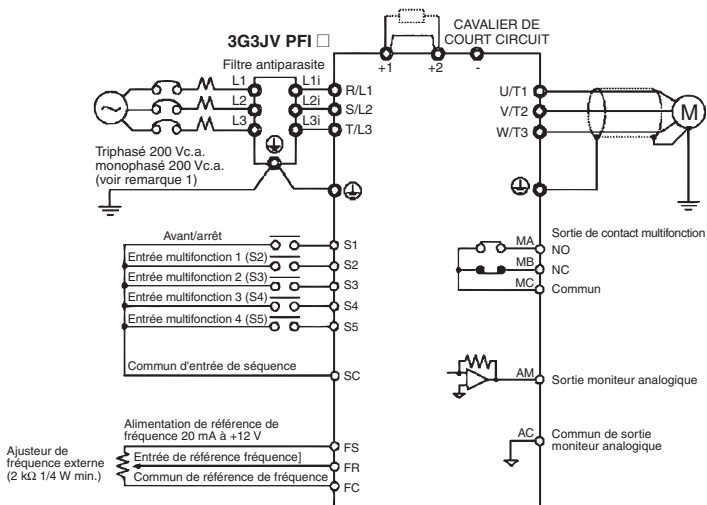

Remarque 1 : Connectez le monophasé 200 Vc.a. aux bornes R/L1 et S/L2 du J7AZB

Remarque 2 : La résistance de freinage ne peut être connectée car aucun transistor de freinage n'est incorporé.

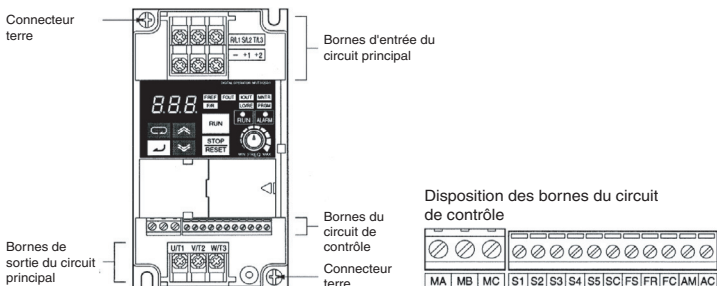

2. Bornes de circuit de contrôle

Symbole	Nom	Fonction	Niveau du signal	
Entrée	S1	Avant/arrêt	Marche sur ON/Arrêt sur OFF	
	S2	Entrée multifonction 1	Définie par le paramètre n36 (Inversion/arrêt) ^{*2}	
	S3	Entrée multifonction 2	Définie par le paramètre n37 (Erreur externe : NO) ^{*2}	
	S4	Entrée multifonction 3	Définie par le paramètre n38 (réinitialisation de l'erreur) ^{*2}	
	S5	Entrée multifonction 4	Définie par le paramètre n39 (Référence à étapes multiples 1) ^{*2}	
	SC	Commun d'entrée de séquence	Commun pour S1 à S5	
	FS	Alimentation de la référence de fréquence	Alimentation c.c. pour la référence de fréquence	20 mA à 12 Vc.c.
	FR	Entrée de référence de fréquence	Borne d'entrée pour la référence de fréquence	0 à 10 V c.c. (20 kΩ)
Sortie	MA	Sortie multifonction : NO	Définie par le paramètre n40 (pendant le fonctionnement) ^{*2}	Sortie relais 1 A max. à 30 Vc.c.
	MB	Sortie multifonction : NC		
	MC	Commun de sortie multifonction	Commun pour l'utilisation de MA et MB	250 Vc.a.
	AM	Sortie moniteur analogique	Définie par le paramètre n44 (fréquence de sortie) ^{*2}	12 mA max. à 0 à 10 Vc.c.
	c.a.	Commun de sortie moniteur analogique	Commun pour l'utilisation AM	

*1 NPN est le paramètre de ces bornes. Aucune alimentation externe n'est nécessaire. Consultez les connexions illustrées ci-après

*2 Les fonctions entre parenthèses sont les paramètres par défaut.

Choix de la méthode d'entrée

Les commutateurs SW7 et SW8, tous deux situés au-dessus des bornes du circuit de contrôle, servent à la sélection de la méthode d'entrée.

Enlevez le capot avant et le capot en option pour pouvoir utiliser ces commutateurs.

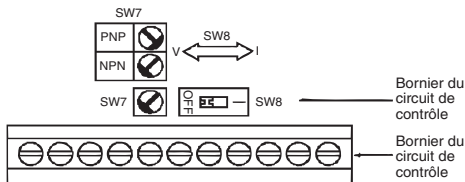

Choix de la méthode d'entrée de séquence

Si vous utilisez SW7, NPN ou PNP, vous pouvez choisir les entrées de la manière suivante.

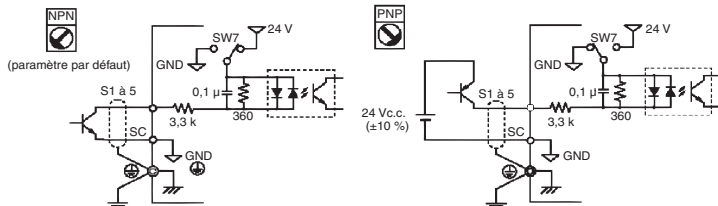

3. Installation

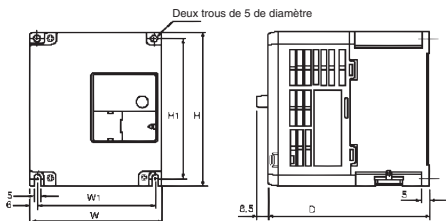

Tension nominale	Modèle J7AZ	Dimensions (mm)					Conseil d'alimentation	
		I	H	P	L1	H1	MCCB (A)	Câble (mm ²)
Triphasé 200 Vc.a.	20P1	68	128	70	56	118	5	2
	20P2	68	128	70	56	118	5	2
	20P4	68	128	102	56	118	5	2
	20P7	68	128	122	56	118	10	2
	21P5	108	128	129	96	118	20	2
	22P2	108	128	154	96	118	20	3,5
Monophasé 200 Vc.a.	24P0	140	128	161	128	118	30	5,5
	B0P1	68	128	70	56	118	5	2
	B0P2	68	128	70	56	118	5	2
	B0P4	68	128	112	56	118	10	2
	B0P7	108	128	129	96	118	20	3,5
	B1P5	108	128	154	96	118	20	5,5
Triphasé 400 Vc.a.	40P2	108	128	81	96	118	5	2
	40P4	108	128	99	96	118	5	2
	40P7	108	128	129	96	118	5	2
	41P5	108	128	154	96	118	10	2
	42P2	108	128	154	96	118	10	2
	43P0	140	128	161	128	118	20	2
44P0	140	128	161	128	118	20	2	

Caractéristiques du filtre d'entrée

Modèle J7AZ	Filtre 3G3JV-	Dimensions						
		I	L	H	Y	X	d	
20P1	PFI2010-SE	82	194	50	92	181	5,3	
20P2								
20P4								
20P7								
21P5	PFI2020-SE	111	169	50	91	156	5,3	
22P2								
24P0	PFI2030-SE	144	174	50	120	161	5,3	
B0P1	PFI1010-SE	71	169	45	51	156	5,3	
B0P2								
B0P4								
B0P7	PFI1020-SE	111	169	50	91	156	5,3	
B1P5								

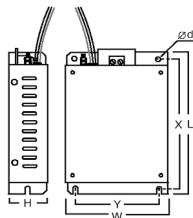

Modèle J7AZ	Filtre 3G3JV-	Dimensions					
		l	L	H	Y	X	d
40P2	PFI3005-SE	111	169	50	91	156	5,3
40P4							
40P7							
41P5	PFI3010-SE	111	169	50	91	156	5,3
42P2							
43P0							
44P0	PFI3020-SE	144	174	50	120	161	5,3

Installation du filtre d'entrée et J7

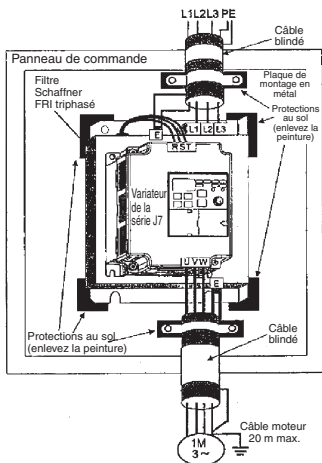

CIMR-J7□□□□20P1 à 24P0
 CIMR-J7□□□□40P2 à 44P0

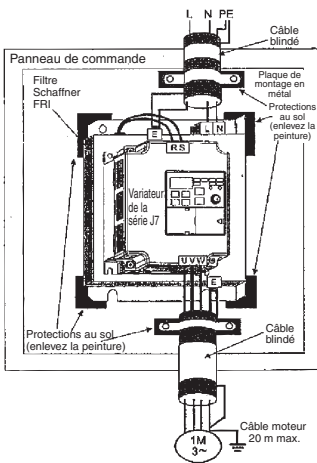

CIMR-J7□□□□B0P1 à B4P0



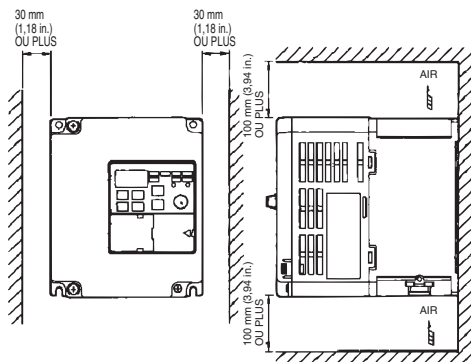





Dimensions de montage



4. Démarrage et essai



Présentation	Nom	Fonction
	Affichage des données	Affiche les données pertinentes, telles que la référence de fréquence, la fréquence de sortie et les valeurs définies des paramètres.
	Ajusteur FREQ	Définit la référence de fréquence dans une plage entre 0 Hz et la fréquence maximale
	Voyant FREF	La référence de fréquence peut être surveillée ou définie quand ce voyant est allumé.
	Voyant FOUT	La fréquence de sortie du variateur peut être surveillée ou définie quand ce voyant est allumé.
	Voyant IOUT	Le courant de sortie du variateur lorsque ce voyant est allumé.
	Voyant MNTR	Les valeurs définies dans U01 à U10 sont surveillées quand ce voyant est allumé.
	Voyant F/R	Le sens de rotation peut être sélectionné quand ce voyant est allumé pendant le fonctionnement du variateur via la touche RUN

Présentation	Nom	Fonction
	Voyant LO/RE	Le fonctionnement du variateur via la console numérique ou selon les paramètres définis peut être sélectionné quand ce voyant est allumé. Remarque : Le statut de cet indicateur ne peut être surveillé que lorsque le variateur fonctionne. Toute entrée de commande RUN est ignorée quand l'indicateur est allumé
	Voyant PRGM	Le paramètre dans n01 à n79 peut être défini ou surveillé quand ce voyant est allumé. Remarque: Pendant le fonctionnement du variateur, les paramètres peuvent seulement être surveillés et il n'est possible de modifier que certains paramètres. Toute entrée de commande RUN est ignorée quand ce voyant est allumé
	Touche Mode	Commute les voyants de réglage et de surveillance de manière séquentielle. Le paramètre en cours de réglage est annulé en cas d'actionnement de cette touche avant l'entrée du paramètre.
	Touche d'augmentation	Augmente les numéros de surveillance multifonction, les numéros de paramètres et les valeurs de définition des paramètres.
	Touche de diminution	Diminue les numéros de surveillance multifonction, les numéros de paramètres et les valeurs de définition des paramètres.
	Touche Entrée	Entre les numéros de surveillance multifonction, les numéros de paramètres et les valeurs de données internes après leur définition ou modification.
	Touche RUN	Démarre le variateur quand le 3G3MV fonctionne avec la console numérique
	Bouton Stop/Reset	Arrête le variateur sauf si le paramètre n06 n'est pas configuré pour désactiver la touche STOP.

Les sept étapes suivantes décrivent les opérations minimales recommandées afin que le J7 puisse contrôler un moteur connecté en mode de configuration standard et pour permettre un fonctionnement simple le plus rapidement possible :

Étape1 – vérification initiales

1-1 Points de contrôle avant de connecter l'alimentation.

Vérifiez que l'alimentation reçoit la bonne tension.

CIMR-J7AZ2□□□□: Triphasé 200 à 230 Vc.a.

CIMR-J7AZB□□□□: Monophasé 200 à 240 Vc.a. (Câble R/L1 et S/L2)

CIMR-J7AZ4□□□□: Triphasé 380 à 460 Vc.a.

1-2 Veillez à ce que les bornes de sortie du moteur (U/T1, V/T2, W/T3) soient correctement connectées au moteur.

1-3 Veillez à ce que la borne du circuit de contrôle et l'appareil de contrôle soient correctement câblés.

1-4 Veillez à ce que toutes les bornes de contrôle soient hors tension.

1-5 Affectez le statut sans charge au moteur (c-à-d. pas connecté au système mécanique)

Étape2 – Connexion de l'alimentation et vérification de l'état de l'affichage

2-1 Lorsque les vérifications de l'étape 1 sont terminées, connectez l'alimentation.

2-2 Si l'affichage est normal lors de la connexion de l'alimentation, il apparaîtra comme suit :

voyant RUN : clignote

Voyant ALARM : off

Voyants réglage/surveillance : FREF, FOUT ou IOUT est allumé.

Affichage des données : affiche les données correspondant au voyant allumé.

Lorsqu'une erreur s'est produite, les détails de l'erreur s'affichent. Dans ce cas, consultez le manuel de l'utilisateur et prenez les mesures nécessaires.

Etape3 – Initialisation des paramètres

Pour initialiser les paramètres du variateur aux valeurs par défaut définies en usine, définissez le paramètre n01 = 8. Le J7 acceptera ainsi les commandes marche/arrêt pour ce que nous avons appelé le « contrôle à 2 câbles », c-à-d. 1 câble pour la commande marche/arrêt d'un moteur et 1 câble pour la commande inversion/arrêt d'un moteur.

Touche Séquence	Voyant	Exemple d'affichage	Explication
			Sous tension
			Appuyez plusieurs fois sur la touche Mode jusqu'à ce que le voyant PRGM s'allume.
			Appuyez sur la touche Entrée. Les données de n01 s'affichent.
			Utilisez la touche Augmenter ou Diminuer pour attribuer la valeur 8 à n01. L'affichage clignotera.
			Appuyez sur la touche Entrée pour valider la valeur définie et l'affichage des données s'allumera.
Environ en 1s.			Le chiffre du paramètre s'affiche.

Etape4 – Définition du courant nominal du moteur

Ce paramètre est utilisé pour la fonction thermique électronique de détection de surcharge du moteur (OL1). Lorsqu'il est correctement paramétré, le J7 empêche un moteur surchargé de brûler.

Vérifiez la valeur du courant nominal (en ampères) sur la plaque d'identification du moteur et saisissez-la pour le paramètre n32. L'exemple ci-dessous illustre la saisie de la valeur 1,8 Amp.

Touche Séquence	Voyant	Exemple d'affichage	Explication
			Affiche le numéro du paramètre.
			Utilisez la touche Augmenter ou Diminuer jusqu'à ce que n32 s'affiche.
			Appuyez sur la touche Entrée. Les données de n32 s'affichent.
			Utilisez la touche Augmenter ou Diminuer pour définir le courant nominal du moteur. L'affichage clignotera.
			Appuyez sur la touche Entrée pour valider la valeur définie et l'affichage des données s'allumera.
Environ en 1s			Le chiffre du paramètre s'affiche.

Etape5 – Définition de la fréquence nominale du moteur

Il s'agit de la fréquence maximale à laquelle peut tourner le moteur. Elle permet également au J7 de contrôler correctement le moteur. Vérifiez la fréquence nominale (en Hz) sur la plaque d'identification du moteur et saisissez-la pour les paramètres n09 et n11.

Etape6 – Définition de la commande de fonctionnement

Il s'agit de la méthode de commande de marche et d'arrêt du moteur (c-à-d la manière dont le variateur démarrera et arrêtera le moteur). Les deux opérations de base sont pour les touches RUN et STOP/RESET de l'opérateur numérique ou pour l'une des entrées multifonctions via les bornes du circuit de contrôle.

Pour définir la commande de fonctionnement, saisissez la valeur adéquate pour le paramètre n02 :

0 = les touches RUN et STOP/RESET de l'opérateur numérique sont activées.

1 = Entrées multifonctions via les bornes du circuit de contrôle.

Le diagramme ci-dessous illustre la manière de connecter un interrupteur pour démarrer/arrêter le moteur en avant en mode « contrôle par 2 câbles ». Définissez le paramètre n02=1. Pour activer un autre interrupteur pour le fonctionnement en marche arrière sur la borne de contrôle S2, définissez le paramètre n36=2 (en fait, la valeur définie par défaut en usine).

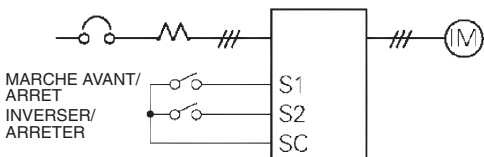

Etape7 – Réglage de la référence de fréquence

Il s'agit de la méthode de sélection de la source pour la commande de vitesse du moteur. La valeur par défaut d'usine est définie pour le potentiomètre sur l'opérateur numérique (ajusteur FREF). Dans ce cas, aucun réglage n'est nécessaire.

La référence de fréquence peut également provenir d'un potentiomètre externe, d'une sortie analogique d'un API ou de 8 vitesses maximum pré-programmées dans le variateur et sélectionnées via les entrées multifonctions.

Par exemple, pour accepter la référence de fréquence en provenance d'un potentiomètre externe ou d'une sortie analogique de 0-10 V d'un API, définissez le paramètre n03=2.

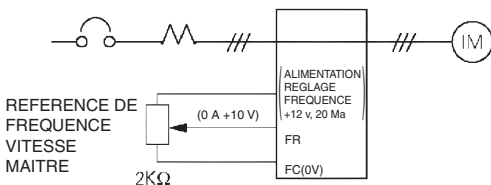

5. Aperçu de la liste des paramètres*1

N° du paramètre	Description	Plage	Par défaut
n01	Accès aux paramètres : 0: Accès limité au paramètre 1: Accès complet au paramètre 8: Initialisation du paramètre en usine	0 à 9	1
n02	Sélection de la commande d'exécution : 0: Opérateur numérique 1: Borne de circuit de contrôle 2: Communication (option)	0 à 2	0
n03	Sélection de la référence de fréquence : 0: Opérateur numérique (potentiomètre) 1: Référence de fréquence 1 (n21) 2: Borne du circuit de contrôle (0 à 10 V) 3: Borne du circuit de contrôle (4 à 20 mA) 4: Borne du circuit de contrôle (0 à 20 mA) 6: Communication (option)	0 à 4, 6	0
n09	Fréquence de sortie maximale	50 à 400 Hz	
n10	Tension de sortie maximale	1 à 255 V (classe 200 V) 1 à 510 V (classe 400 V)	200 (classe 200 V) 400 (classe 400 V)
N11	Fréquence de sortie de tension maximale	50 à 400 Hz	
n16	Temps d'accélération 1	0,0 à 999 sec	10 sec
n17	Temps de décélération 2	0,0 à 999 sec	10 sec
n21	Référence de fréquence 1	0,0 à 400 Hz	50Hz
n22 - n28	Référence de fréquence 2 - 8	0,0 à 400 Hz	0 Hz
n32	Courant nominal du moteur	Dépend du modèle	0 à 120% du courant de sortie nominal du variateur
n36 - n39	Entrée multifonction (S2 - S5)	0 à 35	--
n40	Sortie multifonction (MA-MB-MC)	0 à 18	1
n44	Sortie analogique multifonction (AM-AC) : 0: Fréquence de sortie (10 V/max, fréq.) 1: Courant de sortie (10 V/courant nominal du variateur)	0,1	0
n46	Fréquence porteuse	1 à 4 (2,5 – 10 kHz) 7 à 9 (Proportionnel à la fréquence de sortie)	Dépend du modèle
n52	Courant de freinage injection c.c.	0 à 100%	50%
n53	Freinage c.c. à injection à l'arrêt	0 à 100%	50%
n54	Freinage c.c. à injection au démarrage	0 à 100%	50%
n55	Protection anticallage lors de la décélération 0: Activé 1: Désactivé	0,1	0

Entrées multifonctions		Sorties multifonctions	
Valeur*1	Fonction	Valeur*1	Fonction
2	Inverse/arrêt	0	Sortie d'erreur
3	Erreur externe (NO)	1	Pendant fonctionnement
4	Erreur externe (NC)	2	Acceptation de la fréquence
5	Réinitialisation erreur	6	Surcouplage surveillé (NO)
6	Référence de vitesse à étapes multiples 1	12	mode RUN
7	Référence de vitesse à étapes multiples 2	13	Variateur prêt

*1 Consultez le manuel de l'utilisateur pour la liste complète

Entrées multifonctions		Sorties multifonctions	
Valeur*1	Fonction	Valeur*1	Fonction
8	Référence de vitesse à étapes multiples 3	15	Sous-tension en cours
10	Commande pas à pas	Fonctions de sortie analogique	
12	Commande du circuit externe (NO)	Valeur*1	Fonction
13	Commande du circuit externe (NC)	0	Fréquence de sortie
17	Sélection Local/distant	1	Courant de sortie

*1 Consultez le manuel de l'utilisateur pour connaître toutes les valeurs définies

Exemple de réglage de paramètres

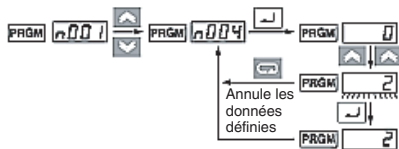

Environ en 1s.

Touche Séquence	Voyant	Exemple d'affichage	Explication
	FREF		Sous tension
	PRGM		Appuyez plusieurs fois sur la touche Mode jusqu'à ce que le voyant PRGM s'allume.
	PRGM		Utilisez la touche Augmenter ou Diminuer pour définir le numéro du paramètre.
	PRGM		Appuyez sur la touche Entrée. Les données du numéro de paramètre sélectionné s'afficheront.
	PRGM		Utilisez la touche Augmenter ou Diminuer pour définir les données. A ce moment, l'affichage clignote.
	PRGM		Appuyez sur la touche Entrée pour valider la valeur définie et l'affichage des données s'allumera (cfr remarque 1)
Environ en 1s.	PRGM		Le chiffre du paramètre s'affiche.















Remarque 1 : Pour annuler la valeur définie, appuyez sur la touche Mode. Le numéro du paramètre s'affichera.

- 2 :** Certains paramètres ne peuvent pas être modifiés pendant que le variateur fonctionne. Consultez la liste des paramètres. Si vous essayez de modifier ces paramètres, l'affichage des données ne changera pas en appuyant sur la touche Augmenter ou Diminuer.

6. Moniteurs

Le Vs mini J7 vous permet de surveiller plusieurs situations telles que le courant de sortie et le statut des entrées multifonctions.

Cette surveillance est possible grâce aux paramètres « U ».

Séquence clé	Voyant	Exemple d'affichage	Explication
			Sous tension
			Appuyez plusieurs fois sur la touche Mode jusqu'à ce que le voyant MNTR s'allume. U01 doit s'afficher.
			Utilisez la touche Augmenter ou Diminuer pour choisir l'élément du moniteur à afficher.
			Appuyez sur la touche Entrée pour afficher les données de l'élément du moniteur choisi.
			L'affichage du numéro du moniteur réapparaîtra en appuyant sur la touche de mode.

N° de constante	Nom		Description
U01	Référence de fréquence (FREF)	Hz	La référence de fréquence peut être contrôlée. (comme FREF)
U02	Fréquence de sortie (FOUT)	Hz	La référence de sortie peut être contrôlée. (comme FOUT)
U03	Courant de sortie (IOUT)	A	Le courant de sortie peut être contrôlé. (comme IOUT)
U04	Tension de sortie	V	La tension de sortie peut être contrôlée.
U05	Tension c.c.	V	La tension c.c. du circuit principal peut être contrôlée.
U06	État de la borne d'entrée	--	L'état de la borne d'entrée des bornes du circuit de contrôle peut être contrôlé.
U07	État de la borne de sortie	--	L'état de la borne de sortie des bornes du circuit de contrôle peut être contrôlé.
U09	Historique des erreurs	--	L'historique des quatre dernières erreurs est affiché.
U10	N° logiciel	--	Le n° de logiciel peut être vérifié.
U15	Erreur de réception de données	--	Le contenu de l'erreur de réception de données de communication MEMOBUS peut être vérifié. (le contenu du registre de transmission N° 003DH est identique)

État de la borne d'entrée/sortie

État de la borne d'entrée

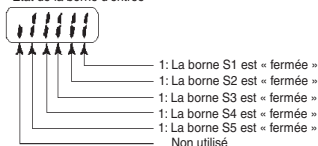

État de la borne de sortie

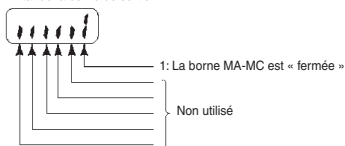

7. Erreurs et alarmes

Affichage de l'erreur	Nom et signification de l'erreur	Cause possible et solution
OC	Surintensité Le courant de sortie est supérieur à 250 % du courant nominal du variateur.	Vérifiez s'il n'y a pas un court-circuit ou une erreur de terre à la sortie. La charge est trop importante. Diminuez-la ou utilisez un plus grand variateur. Vérifiez la valeur nominale FLA du moteur par rapport au variateur et au paramètre V/F.
OV	Sur-tension La tension c.c. du bus a dépassé le niveau de détection.	L'inertie de la charge est trop importante et le moteur se régénère. Augmentez le temps de décélération (n020 ou n022). Connectez une résistance de freinage externe et attribuez la valeur 1 à n092. Vérifiez la résistance de freinage et le câblage.
uV1	Sous-tension du circuit principal La tension c.c. du bus a inférieure au niveau de détection.	Vérifiez la tension d'alimentation principale ainsi que les connexions. Vérifiez que l'alimentation est correcte pour le variateur utilisé. Surveillez les DIP du circuit ou les interruptions.
OH	Surchauffe de l'unité La température à l'intérieur du variateur a dépassé 110 °C.	Consultez le manuel pour les instructions et recommandations d'installation. Contrôlez le ventilateur (s'il est fixé). Contrôlez les caractéristiques V/F ou diminuez la fréquence porteuse.
OL1	Surcharge du moteur Le variateur protège le moteur d'une surcharge d'après un calcul IP interne sur le paramètre n036.	Vérifiez et diminuez la charge. Vérifiez les caractéristiques V/F (V_{max} et F_{max}). Augmentez la vitesse de fonctionnement du moteur. Augmentez les temps d'accélération/décélération.
EF ¹	Erreur externe Une erreur externe a été entrée.	Vérifiez le câblage de votre borne de contrôle. Une entrée numérique multifonction a été définie à 3 ou 4. Il faut supprimer le signal d'exécution avant de pouvoir réinitialiser cette entrée.
SER (clignotement)	Erreur de séquence Entrée de séquence pendant le fonctionnement du variateur.	Il faut arrêter le variateur en cas de tentative de commutation Local/Distant. Il faut arrêter le variateur en cas de tentative de commutation Comm/Distant.
bb (clignotement)	Étage de sortie bloqué externe Une commande d'étage de sortie bloqué externe a été entrée.	Vérifiez le câblage de votre borne de contrôle. Une entrée numérique multifonction a été définie à 12 ou 13.
EF (clignotement)	Une erreur de séquence s'est produite	Un signal de fonctionnement avant et inverse a été demandé en même temps.

*1 Consultez le manuel de l'utilisateur pour connaître toute la liste des code d'erreur

VS MINI J7

Guida di avvio rapido

1. Cablaggio
2. Terminali circuito di controllo
3. Installazione
4. Avvio e collaudo
5. Elenco dei parametri principali
6. Funzioni di monitoraggio
7. Errori e allarmi

1. Cablaggio

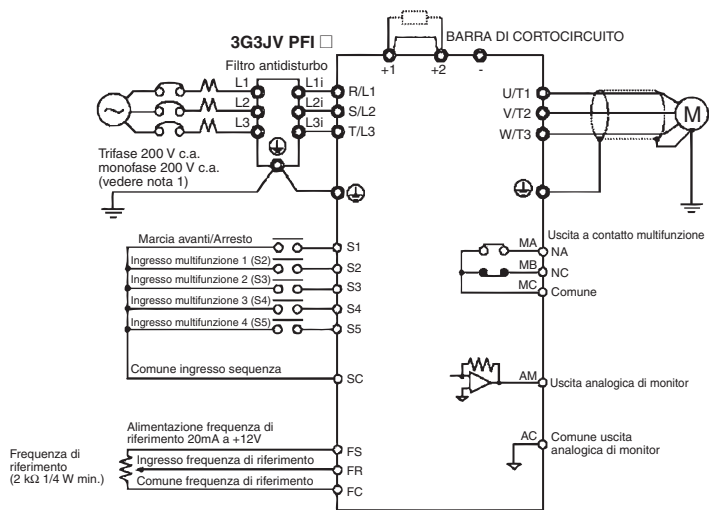

Nota 1: Collegare il circuito monofase 200 V c.a. ai terminali R/L1 e S/L2 del J7AZB

Nota 2: Non è possibile collegare la resistenza di frenatura perché non è integrato alcun transistor di frenatura.

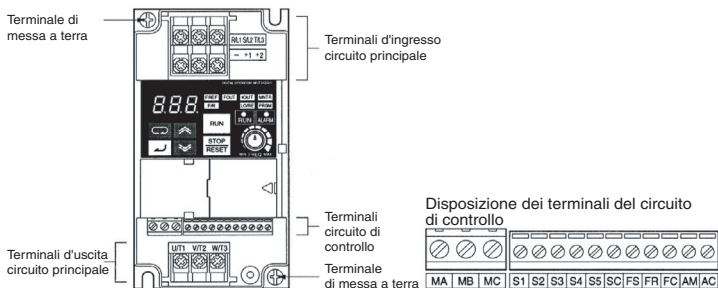

2. Terminali circuito di controllo

Simbolo	Descrizione	Funzione	Livello del segnale	
Ingresso	S1	Marcia avanti/Arresto		
	S2	Ingresso multifunzione 1	Impostato con il parametro n36 (Marcia indietro/Stop) ²	Fotoaccoppiatore, 8 mA a 24 V c.c. ¹
	S3	Ingresso multifunzione 2	Impostato con il parametro n37 (Errore esterno: NA) ²	
	S4	Ingresso multifunzione 3	Impostato con il parametro n38 (Sblocco errore) ²	
	S5	Ingresso multifunzione 4	Impostato con il parametro n39 (Multivelocità di riferimento 1) ²	
	SC	Comune ingressi multifunzione	Comune per S1... S5	
	FS	Alimentazione frequenza di riferimento	Alimentazione c.c. per l'utilizzo della frequenza di riferimento	20 mA a 12 V c.c.
	FR	Ingresso frequenza di riferimento	Terminale di ingresso per l'utilizzo della frequenza di riferimento	0 a 10 V c.c. (20 kΩ)
	FC	Comune frequenza di riferimento	Comune per l'utilizzo della frequenza di riferimento	4 a 20 mA Da 0 a 20 mA
Uscita	MA	Uscita multifunzione: NA	Impostata dal parametro n40 (durante il funzionamento) ²	Uscita relè 1 A max. a 30 V c.c. e 250 V c.a.
	MB	Uscita multifunzione: NC		
	MC	Comune uscita multifunzione	Comune per l'utilizzo di MA e MB	
	AM	Uscita analogica di monitor	Impostata dal parametro n44 (frequenza di uscita) ²	12 mA max. da 0 a 10 V c.c.
	AC	Comune uscita analogica di monitor	Comune per l'utilizzo di AM	

*1 L'impostazione di questi terminali è NPN. Non è necessaria alcuna alimentazione esterna. Fare riferimento ai collegamenti mostrati qui di seguito

*2 Le funzioni tra parentesi sono impostazioni predefinite.

Selezione del metodo di ingresso

Gli interruttori SW7 e SW8, entrambi posizionati sopra i terminali del circuito di controllo, servono per selezionare il metodo di ingresso.

Per utilizzare questi interruttori occorre rimuovere la copertura frontale e quella opzionale.

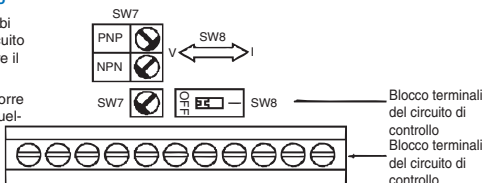

Selezione del metodo di ingresso sequenza

Utilizzando SW7, è possibile selezionare l'ingresso NPN o PNP come mostrato qui di seguito

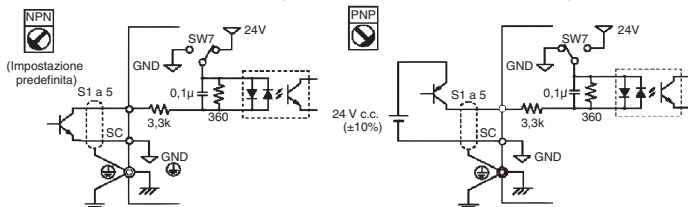

3. Installazione

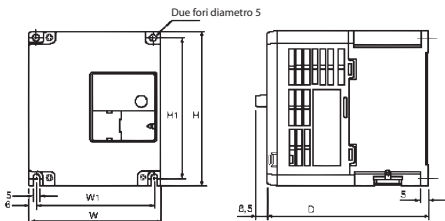

Tensione nominale	Modello J7AZ	Dimensioni (mm)					Raccomandazioni per l'alimentazione	
		W	H	D	W1	H1	MCCB (A)	Filo (mm ²)
Trifase 200 V c.a.	20P1	68	128	70	56	118	5	2
	20P2	68	128	70	56	118	5	2
	20P4	68	128	102	56	118	5	2
	20P7	68	128	122	56	118	10	2
	21P5	108	128	129	96	118	20	2
	22P2	108	128	154	96	118	20	3,5
	24P0	140	128	161	128	118	30	5,5
Monofase 200 V c.a.	B0P1	68	128	70	56	118	5	2
	B0P2	68	128	70	56	118	5	2
	B0P4	68	128	112	56	118	10	2
	B0P7	108	128	129	96	118	20	3,5
	B1P5	108	128	154	96	118	20	5,5
	40P2	108	128	81	96	118	5	2
Trifase 400 V c.a.	40P4	108	128	99	96	118	5	2
	40P7	108	128	129	96	118	5	2
	41P5	108	128	154	96	118	10	2
	42P2	108	128	154	96	118	10	2
	43P0	140	128	161	128	118	20	2
	44P0	140	128	161	128	118	20	2

Caratteristiche del filtro antidisturbo

Modello J7AZ	Filtro 3G3JV-	Dimensioni					
		W	L	H	Y	X	d
20P1	PFI2010-E	82	194	50	92	181	5,3
20P2							
20P4							
20P7							
21P5	PFI2020-E	111	169	50	91	156	5,3
22P2							
24P0	PFI2030-E	144	174	50	120	161	5,3
B0P1	PFI1010-E	71	169	45	51	156	5,3
B0P2							
B0P4							
B0P7	PFI1020-E	111	169	50	91	156	5,3
B1P5							

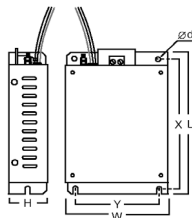

Modello	Filtro	Dimensioni					
		W	L	H	Y	X	d
40P2	PFI3005-E	111	169	50	91	156	5,3
40P4							
40P7							
41P5							
42P2	PFI3010-E	111	169	50	91	156	5,3
43P0							
44P0							

Installazione del filtro antidisturbo e del J7

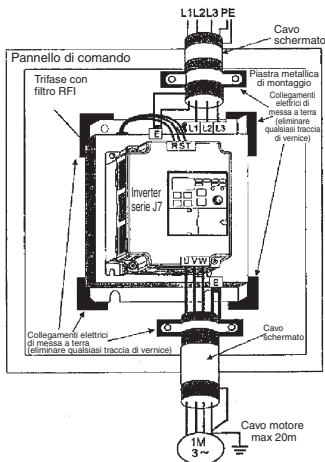

CIMR-J7□□□□ da 20P1 a 24P0
 CIMR-J7□□□□ da 40P2 a 44P0

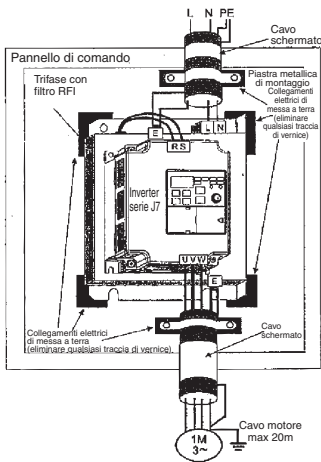

CIMR-J7□□□□ da B0P1 a B4P0



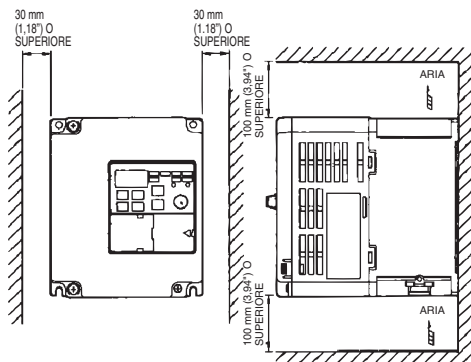





Dimensioni di montaggio



4. Avvio e collaudo



Aspetto	Nome	Funzione
	Visualizzazione dati	Visualizza dati rilevanti, quali frequenza di riferimento, frequenza di uscita e valori impostati per parametri.
	Potenziometro FREQ	Imposta la frequenza di riferimento all'interno della gamma compresa tra 0 Hz e la frequenza massima.
	Spia FREQ	Quando questa spia è accesa, è possibile monitorare o impostare la frequenza di riferimento.
	Spia FOUT	Quando questa spia è accesa, è possibile monitorare o impostare la frequenza di uscita dell'inverter.
	Spia IOUT	Quando questa spia è accesa, è possibile monitorare la corrente di uscita dell'inverter.
	Spia MNTR	Quando questa spia è accesa, vengono monitorati i valori impostati nei parametri U01 ... U10.
	Spia F/R	Quando questa spia è accesa, è possibile selezionare la direzione di rotazione se l'inverter è stato azionato tramite il tasto RUN.

Aspetto	Nome	Funzione
	Spia LO/RE	Quando questa spia è accesa, è possibile selezionare se il funzionamento dell'inverter è controllato mediante la console di programmazione o in base ai parametri impostati. Nota Lo stato di questa spia può essere monitorato solo quando l'inverter è in funzione. Qualsiasi comando di marcia viene ignorato se questa spia è accesa.
	Spia PRGM	Quando questa spia è accesa, è possibile impostare o monitorare i parametri n01 ... n79 Nota: Quando l'inverter è in funzione, è possibile monitorare i parametri, ma solo alcuni di essi possono essere modificati. Qualsiasi comando di marcia viene ignorato se questa spia è accesa.
	Tasto di selezione modalità	Scorre in sequenza le spie di impostazione e monitoraggio. Premendo questo tasto prima dell'inserimento dell'impostazione, è possibile cancellare le modifiche apportate al parametro.
	Tasto di incremento	Incrementa i numeri dei parametri e i valori impostati dei parametri.
	Tasto di decremento	Decrementa i numeri dei parametri e i valori impostati dei parametri.
	Tasto di invio	Permette di inserire i numeri dei parametri e i valori dei dati interni dopo che sono stati impostati o modificati.
	Tasto RUN	Avvia la marcia dell'inverter quando il 3G3JV viene azionato mediante la console di programmazione
	Tasto STOP/RESET	Arresta l'inverter a meno che il parametro n06 non sia impostato per la disabilitazione del tasto STOP.

Le sette fasi descritte qui di seguito rappresentano le operazioni minime raccomandate per consentire al J7 di controllare un motore collegato nella configurazione tipica, così da garantire la massima semplicità di funzionamento nel minor tempo possibile.

Fase 1 – Controlli iniziali

- 1-1 Verifiche da effettuare prima di collegare l'alimentazione.
Verificare che la tensione di alimentazione sia appropriata.
CIMR-J7AZ2□□□: Trifase tra 200 e 230V c.a.
CIMR-J7AZB□□□: Monofase tra 200 e 240V c.a. (Filo R/L1 e S/L2)
CIMR-J7AZ2□□□: Trifase tra 380 e 460V c.a.
- 1-2 Verificare che i terminali di uscita del motore (U/T1, V/T2, W/T3) siano collegati al motore.
- 1-3 Verificare che i terminali del circuito di controllo e il dispositivo di controllo siano collegati correttamente.
- 1-4 Verificare che tutti i terminali di controllo siano disattivati.
- 1-5 Impostare il motore in stato di assenza di carico (ossia non collegato al sistema meccanico).

Fase 2 – Collegamento dell'alimentazione e verifica dello stato del display

- 2-1 Dopo aver effettuato le verifiche descritte nella fase 1, collegare l'alimentazione.

2-2 In caso di funzionamento normale, una volta collegata l'alimentazione il display apparirà come segue:

Spia di MARCIA: lampeggiante

Spia di ALLARME: spenta

Spie dei parametri da impostare/monitorare: FREF, FOUT o IOUT accesa.

Visualizzazione dati: visualizzazione dei dati relativi alla spia accesa.

Se si è verificato un errore, i relativi dettagli verranno visualizzati sul display. In tal caso, fare riferimento al manuale per l'utente e adottare le misure consigliate.

Fase 3 – Inizializzazione dei parametri

Per inizializzare i parametri secondo le impostazioni di fabbrica, occorre impostare il parametro n01 = 8. In tal modo, il J7 accetterà i comandi di avvio/arresto nel cosiddetto "controllo a 2 fili", cioè 1 filo per il comando marcia avanti/arresto e 1 filo per il comando marcia indietro/arresto.

Tasto Sequenza	Spia	Visualizzazione Esempio	Spiegazione
			Accensione
			Premere ripetutamente il tasto di selezione modalità fino all'accensione della spia PRGM.
			Premere il tasto ENTER. Verranno visualizzati i dati del parametro n01.
			Premere il tasto di incremento o decremento per impostare il parametro n01 a 8. Il display inizierà a lampeggiare.
			Premere il tasto ENTER per inserire il valore impostato e visualizzarlo sul display.
Approssimativamente in 1s.			Il numero del parametro verrà visualizzato.

Fase 4 – Impostazione della corrente nominale del motore.

Questo parametro viene utilizzato per attivare la funzione termica elettronica di rilevamento di sovraccarico motore (OL1). La corretta impostazione di questo parametro permette a J7 di evitare la fusione di un motore sovraccarico.

Leggere il valore della corrente nominale (in A) sulla targa del motore e inserirlo nel n32. L'esempio riportato qui di seguito illustra l'inserimento di un valore di 1,8 A.

Tasto Sequenza	Spia	Visualizzazione Esempio	Spiegazione
			Visualizza il numero del parametro.
			Utilizzare il tasto di incremento o decremento per visualizzare il parametro n32.
			Premere il tasto ENTER. Verranno visualizzati i dati del parametro n32.
			Premere il tasto di incremento o decremento per impostare la corrente nominale del motore. Il display inizierà a lampeggiare.
			Premere il tasto ENTER per inserire il valore impostato e visualizzarlo sul display.
Approssimativamente in 1 s.			Il numero del parametro verrà visualizzato.

Fase 5 – Impostazione della frequenza nominale del motore.

Questo valore rappresenta la frequenza massima di funzionamento del motore. La sua impostazione consente al J7 di controllare correttamente il motore. Leggere il valore della frequenza nominale (in Hz) sulla targa del motore e inserirlo nei parametri n09 e n11.

Fase 6 – Impostazione del metodo di funzionamento.

Si tratta dell'impostazione del metodo di funzionamento dei comandi di avvio e arresto del motore (cioè in che modo l'inverter avvia e arresta il motore). Le due modalità di base prevedono l'utilizzo dei tasti RUN e STOP/RESET della console di programmazione o di uno degli ingressi multifunzione tramite i terminali del circuito di controllo.

Per impostare il comando di funzionamento, inserire il valore appropriato nel parametro 02:

0 = attivazione dei tasti RUN e STOP/RESET nella console di programmazione.

1 = attivazione degli ingressi multifunzione tramite i terminali del circuito di controllo.

Il diagramma riportato qui di seguito illustra come collegare un interruttore per avviare e arrestare il motore in marcia avanti nel "controllo a 2 fili". Impostare il parametro n02=1. Per abilitare un interruttore a parte per la marcia indietro sul terminale di controllo S2, impostare il parametro n36=2 (è già l'impostazione predefinita in fabbrica del parametro n36).

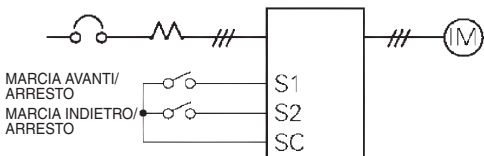

Fase 7 – Impostazione della frequenza di riferimento.

Permette di selezionare la provenienza del comando di velocità del motore. Se si sceglie di utilizzare l'impostazione predefinita in fabbrica che utilizza il potenziometro della console di programmazione (potenziometro FREF), non è necessario inserire alcuna impostazione.

La frequenza di riferimento può provenire anche da un potenziometro esterno, da un'uscita analogica di un PLC, o da una delle 8 velocità predefinite memorizzate nell'inverter e selezionabili mediante gli ingressi multifunzione.

Ad esempio, per selezionare la frequenza di riferimento proveniente da un potenziometro esterno o da un'uscita analogica 0-10V di un PLC, impostare il parametro n03=2.

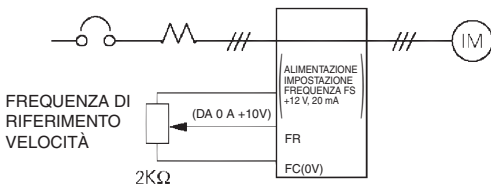

5. Elenco dei parametri principali *1

N. parametro	Descrizione	Range (Ambito)	Valore predefinito
n01	Accesso ai parametri 0: Accesso limitato ai parametri 1: Accesso completo ai parametri 8: Inizializzazione parametri di fabbrica	Da 0 a 9	1
n02	Selezione comando di marcia 0: Console di programmazione: 1: Terminale del circuito di controllo 2: Comunicazione (opzionale)	Da 0 a 2	0
n03	Selezione della frequenza di riferimento 0: Console di programmazione (potenziometro) 1: Frequenza di riferimento 1 (n21) 2: Terminale del circuito di controllo (da 0 a 10V) 3: Terminale del circuito di controllo (da 4 a 20mA) 4: Terminale del circuito di controllo (da 0 a 20mA) 6: Comunicazione seriale (opzionale)	da 0 a 4, 6	0
n09	Frequenza di uscita massima	Da 50 a 400Hz	
n10	Tensione di uscita massima	1 a 255V (classe 200V) Da 1 510V (classe 400V)	200 (classe 200V) 400 (classe 400V)
N11	Frequenza di uscita della tensione massima	Da 50 a 400Hz	
n16	Tempo di accelerazione 1	Da 0,0 a 999sec	10sec
n17	Tempo di decelerazione 2	Da 0,0 a 999sec	10sec
n21	Frequenza di riferimento 1	Da 0,0 a 400Hz	50Hz
n22 - n28	Frequenza di riferimento 2 - 8	Da 0,0 a 400Hz	0Hz
n32	Corrente nominale motore	In base al modello	0 a 120% della corrente di uscita nominale dell'inverter
n36 - n39	Ingresso multifunzione (S2 - S5)	0 a 35	--
n40	Uscita multifunzione (MA-MB-MC)	0 a 18	1
n44	Uscita analogica multifunzione (AM-AC): 0: Frequenza di uscita (10V/freq. max) 1: Corrente di uscita (10V/Corrente nominale dell'inverter)	0,1	0
n46	Frequenza portante	1 a 4 (2,5 - 10kHz) da 7 a 9 (proporzionale alla frequenza di uscita)	In base al modello
n52	Corrente di frenatura ad iniezione c.c.	0 a 100%	50%
n53	Corrente di frenatura a iniezione c.c. all'arresto	0 a 100%	50%
n54	Corrente di frenatura a iniezione c.c. all'avvio	0 a 100%	50%
n55	Prevenzione dello stallo durante la decelerazione 0: Attivata 1: Disattivata	0,1	0

Ingressi multifunzione		Uscite multifunzione	
Valore ^{*1}	Funzione	Valore ^{*1}	Funzione
2	Marcia indietro/arresto	0	Uscita d'errore
3	Errore esterno (NA)	1	Durante la marcia
4	Errore esterno (NC)	2	Raggiungimento frequenza di riferimento
5	Sblocco errore	6	Monitoraggio superamento del momento di rotazione (NA)
6	Multivelocità di riferimento 1	12	Modalità RUN

*1 Per conoscere l'elenco completo, fare riferimento al manuale per l'utente

Ingressi multifunzione		Uscite multifunzione	
Valore*1	Funzione	Valore*1	Funzione
7	Multivelocità di riferimento 2	13	Inverter pronto
8	Multivelocità di riferimento 3	15	Caduta di tensione in corso
10	Comando a impulsi	Funzioni uscita analogica	
12	Blocco delle basi esterno (NA)	Valore*1	Funzione
13	Blocco delle basi esterno (NC)	0	Frequenza di uscita
17	Selezione locale/remota	1	Corrente d'uscita

*1 Per conoscere il valore impostato completo, fare riferimento al manuale per l'utente

Esempio di impostazione dei parametri

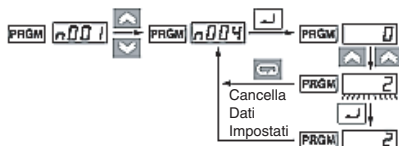

Approssimativamente in 1s.

Tasto Sequenza	Spia	Esempio di visualizzazione	Spiegazione
	PRGM	00	Accensione
	PRGM	n01	Premere ripetutamente il tasto di selezione modalità fino all'accensione della spia PRGM.
	PRGM	n03	Premere il tasto di incremento o decremento per impostare il numero del parametro.
	PRGM	0	Premere il tasto ENTER. Verrà visualizzato il dato relativo al numero del parametro selezionato.
	PRGM	2	Utilizzare il tasto di incremento o decremento per impostare il dato. A questo punto, il display inizierà a lampeggiare.
	PRGM	2	Premere il tasto ENTER per inserire il valore impostato e visualizzarlo sul display (vedere nota 1)
Approssimativamente in 1s.	PRGM	n03	Il numero del parametro verrà visualizzato.

Nota 1: Se invece si desidera cancellare il valore impostato, premere il tasto di selezione modalità. Verrà visualizzato il numero del parametro.

2: Alcuni parametri non possono essere modificati quando l'inverter è in funzione. Fare riferimento all'elenco dei parametri. Se si cerca di modificare tali parametri, il dato visualizzato non cambia nonostante venga premuto il tasto di incremento o decremento.

6. Funzioni di monitoraggio

Il J7 permette di monitorare varie condizioni, quali la corrente di uscita e lo stato degli ingressi multifunzione.

Tale monitoraggio viene effettuato mediante i parametri a "U".

Sequenza di tasti	Spia	Esempio di visualizzazione	Spiegazione
			Accensione
			Premere ripetutamente il tasto di selezione modalità fino all'accensione della spia MNTR. Verrà visualizzato U01.
			Utilizzare il tasto di incremento o decremento per selezionare l'elemento monitorato da visualizzare.
			Premere il tasto ENTER per visualizzare il dato relativo all'elemento monitorato selezionato.
			Per visualizzare nuovamente il dato dell'elemento monitorato, premere il tasto di selezione modalità.

N. costante	Nome		Descrizione
U01	Frequenza di riferimento (FREF)	Hz	È possibile monitorare la frequenza di riferimento. (Come FREF)
U02	Frequenza di uscita (FOUT)	Hz	È possibile monitorare la frequenza di uscita. (Come FOUT)
U03	Corrente di uscita (IOUT)	A	È possibile monitorare la corrente di uscita. (Come IOUT)
U04	Tensione di uscita	V	È possibile monitorare la tensione di uscita
U05	Tensione c.c.	V	È possibile monitorare la tensione c.c. del circuito principale
U06	Stato terminali di ingresso	--	È possibile monitorare lo stato dei terminali d'ingresso del circuito di controllo
U07	Stato terminali di uscita	--	È possibile monitorare lo stato dei terminali di uscita del circuito di controllo
U09	Storico anomalie	--	Viene visualizzato lo storico delle ultime quattro anomalie
U10	N. software	--	È possibile verificare il n. di software
U15	Errore di ricezione dati	--	È possibile verificare il contenuto degli errori di ricezione dei dati di comunicazione di Modbus (uguale al contenuto del registro di trasmissione N. 003DH)

Stato terminali d'ingresso/uscita

Stato terminali di ingresso

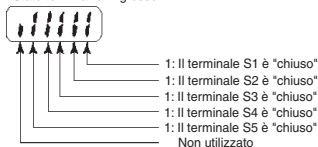

Stato terminali di uscita

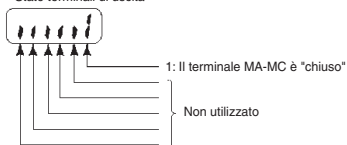

7. Errori e allarmi

Visualizzazione dell'errore	Nome e significato dell'errore	Possibile causa e rimedio
OC	Sovraccorrente La corrente di uscita supera del 250% la corrente nominale dell'inverter	Controllare l'uscita per rilevare eventuali cortocircuiti o errori di messa a terra. Il carico è troppo grande, ridurlo o utilizzare un inverter più potente. Verificare i valori di correzione nominale del motore rispetto all'inverter e all'impostazione V/F.
OV	Sovratensione La tensione del bus in corrente continua ha superato il livello di rilevamento.	L'inerzia del carico è troppo grande e il motore si sta riavviando. Aumentare il tempo di decelerazione (n020 o n022).
uV1	Caduta di tensione del circuito principale La tensione del bus in corrente continua è inferiore al livello di rilevamento.	Controllare la tensione e i collegamenti della rete di alimentazione principale. Verificare che l'alimentazione utilizzata per l'inverter sia adeguata. Verificare l'assenza di interruzioni nella rete di alimentazione principale.
OH	Surriscaldamento unità La temperatura interna dell'inverter ha superato i 110°C.	Fare riferimento alle istruzioni e alle raccomandazioni d'installazione contenute nel manuale per l'utente. Controllare il ventilatore di raffreddamento (se installato). Verificare le caratteristiche V/f o ridurre la frequenza portante.
OL1	Sovraccarico motore L'inverter sta proteggendo il motore dal sovraccarico sulla base di un calcolo interno utilizzando l'impostazione n036.	Controllare e ridurre il carico. Verificare le caratteristiche V/f (V_{max} e F_{max}). Aumentare la velocità di funzionamento del motore. Aumentare i tempi di accelerazione/decelerazione.
EF ¹	Errore esterno È stato introdotto un errore esterno	Controllare il cablaggio dei terminali del circuito di controllo. Un ingresso digitale multifunzione è stato impostato a 3 o 4. Per sbloccare questo errore, è necessario prima eliminare il segnale di marcia.
SER (lampeggiante)	Sequenza di errore Ingresso sequenza durante il funzionamento dell'inverter	Prima di tentare una commutazione locale/remoto, è necessario arrestare l'inverter. Prima di tentare una commutazione comune/remoto, è necessario arrestare l'inverter.
bb (lampeggiante)	Blocco delle basi esterno È stato introdotto un comando di blocco delle basi esterno.	Controllare il cablaggio dei terminali del circuito di controllo. Un ingresso digitale multifunzione è stato impostato a 12 o 13.
EF (lampeggiante)	Si è verificata una sequenza di errore	I segnali di marcia avanti e indietro sono stati attivati contemporaneamente.

¹ Per conoscere l'elenco completo dei codici di errore, fare riferimento al manuale per l'utente

VS MINI J7

Breve Guia de Introdução

1. Cablagem
2. Terminais do circuito de controlo
3. Instalação
4. Arranque e funcionamento experimental
5. Breve lista de parâmetros
6. Monitores
7. Falhas e alarmes

1. Cablagem

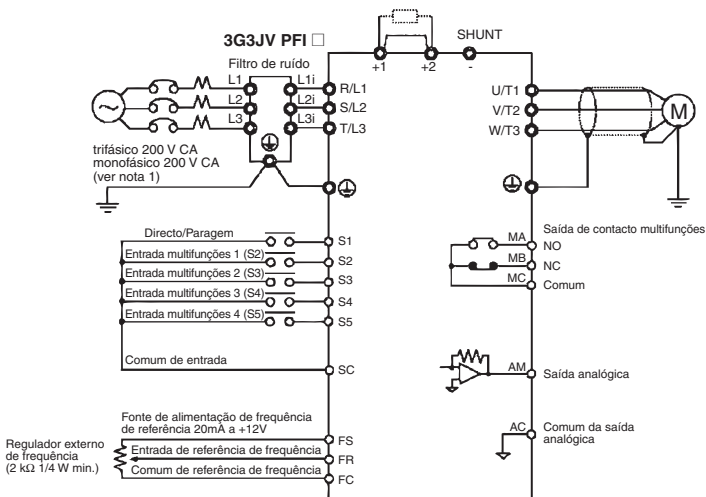

Nota 1: Ligue a tensão monofásica de 200 V CA aos terminais R/L1 e S/L2 de J7AZB

Nota 2: Não é possível ligar a resistência de frenagem, uma vez que não existe qualquer transistor de frenagem incorporado.

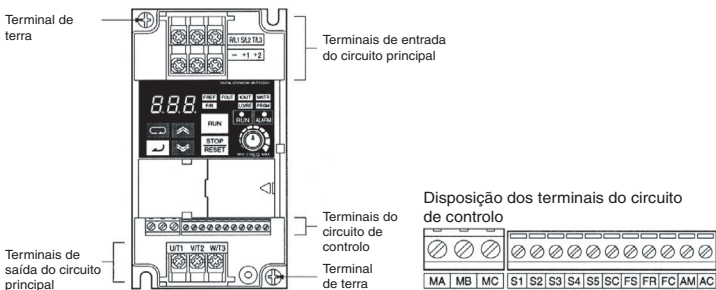

2. Terminais do circuito de controlo

Símbolo	Nome	Função	Nível do sinal	
Entrada	S1	Directo/Paragem	Directo em ON/ Paragem em OFF	Fotoacoplador 8 mA a 24 V CC ^{*1}
	S2	Entrada multifunções 1	Definida pelo parâmetro n36 (Inverso/Paragem) ^{*2}	
	S3	Entrada multifunções 2	Definida pelo parâmetro n37 (Falha externa: NO) ^{*2}	
	S4	Entrada multifunções 3	Definida pelo parâmetro n38 (Reset de falha) ^{*2}	
	S5	Entrada multifunções 4	Definida pelo parâmetro n39 (Referência multi- step 1) ^{*2}	
	SC	Comum de entrada	Comum de S1 até S5	
	FS	Fonte de alimentação da frequência de referência	Fonte de alimentação CC para utilização na frequência de referência	20 mA a 12 V CC
	FR	Entrada de frequência de referência	Terminal de entrada para utilização da frequência de referência	0 a 10 V CC (20 kΩ)
	FC	Comum de frequência de referência	Comum para utilização da frequência de referência	4 a 20 mA 0 a 20 mA
Saída	MA	Saída multifunções: NO	Definida pelo parâmetro n40 (durante o funcionamento) ^{*2}	Saída por relé 1 A máx. a 30 V CC e 250 V CA
	MB	Saída multifunções: NC		
	MC	Comum de saída multifunções	Comum para utilização MA e MB	
	AM	Saída analógica	Definida pelo parâmetro n44 (Frequência de saída) ^{*2}	12 mA máx. de 0 a 10 V CC
	AC	Comum da saída analógica	Comum para utilização de AM	

*1 A definição para estes terminais é NPN. Não é necessária qualquer fonte de alimentação externa. Consulte as ligações mostradas abaixo.

*2 As funções entre parênteses constituem as predefinições.

Seleccionar o método de entrada

Os switches SW7 e SW8, localizados acima dos terminais do circuito de controlo, são utilizados para a selecção do tipo de entrada.

Remove a cobertura da frente e a cobertura opcional para aceder a estes switches.

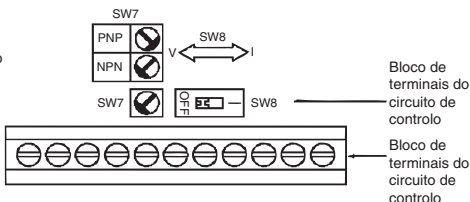

Seleccionar o método de entrada

Ao utilizar SW7, é possível seleccionar a entrada tipo NPN ou PNP conforme mostrado abaixo

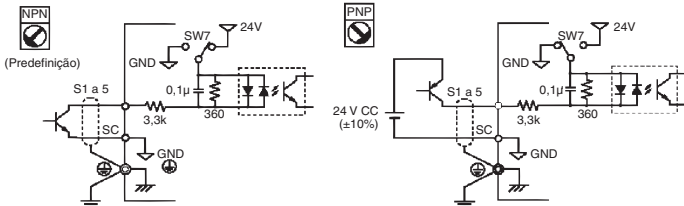

3. Instalação

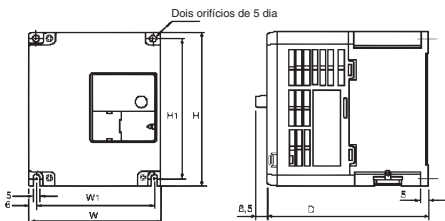

Tensão nominal	Modelo J7AZ	Dimensões (mm)					Recomendações de alimentação	
		W	H	D	W1	H1	MCCB (A)	Fio (mm ²)
Trifásica 200 V CA	20P1	68	128	70	56	118	5	2
	20P2	68	128	70	56	118	5	2
	20P4	68	128	102	56	118	5	2
	20P7	68	128	122	56	118	10	2
	21P5	108	128	129	96	118	20	2
	22P2	108	128	154	96	118	20	3,5
	24P0	140	128	161	128	118	30	5,5
Monofásica 200 V CA	B0P1	68	128	70	56	118	5	2
	B0P2	68	128	70	56	118	5	2
	B0P4	68	128	112	56	118	10	2
	B0P7	108	128	129	96	118	20	3,5
	B1P5	108	128	154	96	118	20	5,5
	40P2	108	128	81	96	118	5	2
Trifásica 400 V CA	40P4	108	128	99	96	118	5	2
	40P7	108	128	129	96	118	5	2
	41P5	108	128	154	96	118	10	2
	42P2	108	128	154	96	118	10	2
	43P0	140	128	161	128	118	20	2
	44P0	140	128	161	128	118	20	2

Especificações do filtro de ruído

Modelo J7AZ	Filtro 3G3JV-	Dimensões					
		W	L	H	Y	X	d
20P1	PFI2010-SE	82	194	50	92	181	5,3
20P2							
20P4							
20P7							
21P5	PFI2020-SE	111	169	50	91	156	5,3
22P2							
24P0	PFI2030-SE	144	174	50	120	161	5,3
B0P1	PFI1010-SE	71	169	45	51	156	5,3
B0P2							
B0P4							
B0P7	PFI1020-SE	111	169	50	91	156	5,3
B1P5							

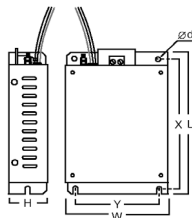

Modelo	Filtro	Dimensões					
		W	L	H	Y	X	d
40P2	PFI3005-SE	111	169	50	91	156	5,3
40P4							
40P7							
41P5							
42P2	PFI3020-SE	144	174	50	120	161	5,3
43P0							
44P0							

Instalação do filtro de ruído e J7

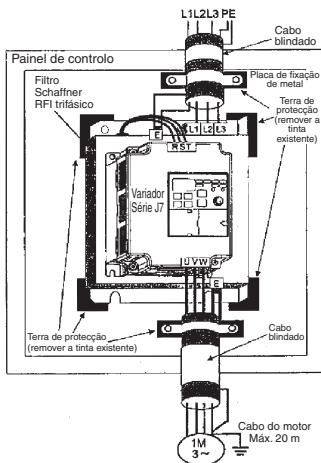

CIMR-J7□□□□20P1 a 24P0
 CIMR-J7□□□□40P2 a 44P0

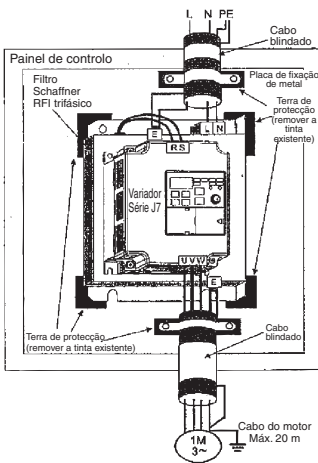

CIMR-J7□□□□B0P1 a B4P0



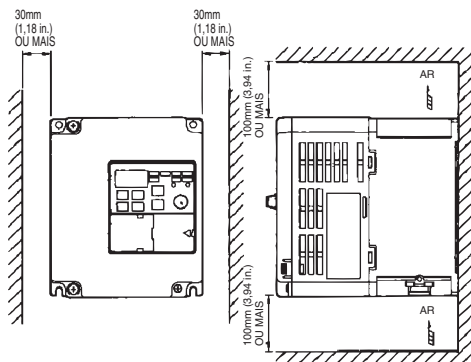





Dimensões de montagem



4. Arranque e funcionamento experimental



Aspecto	Nome	Função
	Visor de apresentação de dados	Apresenta itens de dados relevantes, tais como a frequência de referência, a frequência de saída e valores de parâmetros definidos.
	Regulador de FREQ	Define a frequência de referência num intervalo entre Ohz e a frequência máxima.
	Indicador FREQ	É possível monitorizar ou definir a frequência de referência quando este indicador está iluminado.
	Indicador FOUT	É possível monitorizar ou definir a frequência de saída do Variador quando este indicador está iluminado.
	Indicador IOUT	É possível monitorizar a corrente de saída do variador quando este indicador está iluminado.
	Indicador MNTR	Os valores definidos de U01 a U10 são monitorizados quando este indicador está iluminado.
	Indicador F/R	É possível seleccionar o sentido de rotação quando este indicador está iluminado ao utilizar o Variador recorrendo à tecla RUN.

Aspecto	Nome	Função
	Indicador LO/RE	É possível seleccionar o funcionamento do Variador utilizando a Consola digital ou de acordo com os parâmetros definidos quando este indicador está iluminado. Nota: Só é possível monitorizar o estado deste indicador quando o Variador está em funcionamento. Qualquer entrada do comando RUN é ignorada quando este indicador está iluminado.
	Indicador PRGM	É possível monitorizar ou definir o parâmetro entre n01 e n79 quando este indicador está iluminado. Nota: Quando o Variador está em funcionamento, é possível monitorizar os parâmetros e apenas alguns podem ser alterados. Qualquer entrada do comando RUN é ignorada quando este indicador está iluminado.
	Tecla de modo	Alterna entre os indicadores de itens do monitor e definição em sequência. O parâmetro que está a ser definido é cancelado se esta tecla for premeida antes de introduzir a definição.
	Tecla de incrementar	Incrementa os valores de parâmetros definidos, os números dos parâmetros as posições de monitorização de U01 a U10.
	Tecla de decrementar	Decrementa os valores dos parâmetros definidos, os números dos parâmetros e as posições de monitorização de U01 a U10.
	Tecla Enter	Valida os valores de dados internos, números de parâmetros e as posições de monitorização de U01 a U10 após serem definidos ou alterados.
	Tecla RUN	Inicia o funcionamento do Variador quando o J7 está a funcionar com a Consola digital.
	Tecla STP/RESET	Pára o Variador a menos que o parâmetro n06 esteja definido para desactivar a tecla STOP.

Os sete passos que se seguem descrevem as operações mínimas recomendadas que permitem que o J7 controle um motor ligado numa configuração típica, para um funcionamento simples e de forma rápida:

Passo 1 – Verificações iniciais

- 1-1 Verificações antes de ligar a alimentação.
Verifique se a alimentação tem a tensão correcta.
CIMR-J7AZ2□□□: Trifásica de 200 a 230VCA
CIMR-J7AZB□□□: Monofásica de 200 a 240VCA (Fio R/L1 e S/L2)
CIMR-J7AZ4□□□: Trifásica de 380 a 460VCA
- 1-2 Certifique-se de que os terminais de saída do motor (U/T1, V/T2, W/T3) estão ligados ao motor.
- 1-3 Certifique-se de que os terminais do circuito de controlo e o dispositivo de controlo estão ligados correctamente.
- 1-4 Certifique-se de que todos os terminais de controlo estão desactivados.
- 1-5 Defina o estado do motor para sem carga (ex: sem estar ligado ao sistema mecânico)

Passo 2 – Ligar a alimentação e verificar o estado do visor

- 2-1 Após realizar as verificações no passo 1, ligue de alimentação.
- 2-2 Caso o visor esteja a funcionar normalmente, quando a alimentação é ligada apresenta as seguintes informações:

Indicador RUN: a piscar

Indicador ALARM: desligado





Indicadores de monitorização/definição: FREF, FOUT ou IOUT está iluminado.

Visor de apresentação de dados: apresenta os dados correspondentes ao indicador iluminado.

Quando ocorre uma falha, os detalhes da falha são apresentados. Neste caso, consulte o manual do utilizador e tome as medidas necessárias.







Passo 3 – Inicializar parâmetros

Para inicializar os parâmetros para os predefinidos de fábrica, defina o parâmetro n01 = 8. Este procedimento parametriza o J7 para aceitar os comandos de arranque/paragem conhecidos por “controlo a 2 fios”, ou seja, 1 fio para o comando directo/paragem do motor e um fio para o comando inverso/paragem do motor.

Sequência de teclas	Indicador	Exemplo de visor	Explicação
	FREF	00	Ligado
	PRGM	n01	Prima a tecla de modo repetidamente até que o indicador PRGM fique iluminado.
	PRGM	1	Prima a tecla Enter. São apresentados os dados de n01.
 	PRGM	8	Utilize a tecla de incrementar ou a tecla de decrementar para definir n01 para 8. O visor fica a piscar.
	PRGM	8	Prima a tecla Enter para que o valor definido seja introduzido e o visor de apresentação de dados fique iluminado.
Em aproximadamente 1s.	PRGM	n01	O número do parâmetro é apresentado.

Passo 4 – Definir a corrente nominal do motor

Este parâmetro é utilizado para a função térmica electrónica de detecção de sobrecarga do motor (OL1). Ao parametrizar correctamente esta definição, o J7 protege um motor em sobrecarga de queimar. Consulte a indicação de corrente nominal (em amperes) na placa de identificação do motor e introduza esta informação no parâmetro n32. O exemplo abaixo mostra a introdução de um valor de 1,8 A.

Sequência de teclas	Indicador	Exemplo de visor	Explicação
	PRGM	n01	Apresenta o número do parâmetro
 	PRGM	n32	Utilize a tecla de incrementar ou a tecla de decrementar até que seja apresentado o parâmetro n32.
	PRGM	1.9	Prima a tecla Enter. São apresentados os dados de n32.
 	PRGM	1.8	Utilize a tecla de incrementar ou a tecla de decrementar para definir a corrente nominal do motor. O visor é apresentado a piscar.
	PRGM	1.8	Prima a tecla Enter para que o valor definido seja introduzido e o visor de apresentação de dados fique iluminado.
Em aproximadamente 1s.	PRGM	n32	O número do parâmetro é apresentado.

Passo 5 – Definir a frequência nominal do motor

Trata-se da frequência máxima de funcionamento do motor e permite ao J7 controlar de forma correcta o motor. Consulte a indicação de frequência nominal (em Hz) na placa de identificação do motor e introduza estas informações nos parâmetros n09 e n11.

Passo 6 – Definir o comando de operação

Trata-se do método de comandos para arranque e paragem do motor (ou seja, o modo como o variador arranca e pára o motor). As duas operações básicas são executadas utilizando as teclas RUN e STOP/RESET na Consola digital ou utilizando umas das entradas multifunções através dos terminais do circuito de controlo.

Para definir o comando da operação, introduza o valor apropriado no parâmetro n02:

0 = As teclas RUN e STOP/RESET na Consola digital são activadas.

1 = Entradas multifunções através dos terminais do circuito de controlo.

O diagrama abaixo mostra como ligar um interruptor para arrancar/parar o motor na direcção directa de funcionamento no “controlo a dois fios”. Defina o parâmetro n02=1. Para activar um interruptor em separado para rotação inversa no terminal de controlo S2, defina o parâmetro n36=2 (trata-se na realidade da predefinição de fábrica de n36).

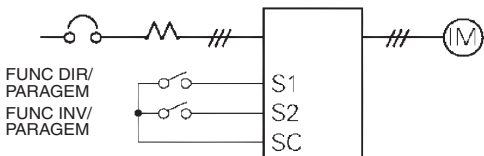

Passo 7 – Definir a frequência de referência

Trata-se do método de selecção da origem para o comando de velocidade do motor. A predefinição de fábrica corresponde ao potenciómetro na Consola digital (regulador FREF), não sendo neste caso necessária qualquer definição.

A frequência de referência também pode ser dada a partir de um potenciómetro externo, uma saída analógica a partir de um PLC ou até 8 velocidades pré-programadas existentes no variador e seleccionadas através das entradas multifunções.

Por exemplo, para aceitar a frequência de referência de um potenciómetro externo ou de uma saída analógica de 0-10V a partir de um PLC, defina o parâmetro n03=2.

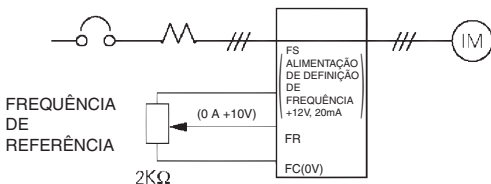

5. Breve lista de parâmetros *1

Nº do parâmetro	Descrição	Intervalo	Predefinição
n01	Acesso a parâmetros: 0: Acesso limitado a parâmetros 1: Acesso total a parâmetros 8: Inicialização dos parâmetros	0 a 9	1
n02	Seleção do comando de arranque: 0: Consola digital 1: Terminal do circuito de controlo 2: Comunicação (opção)	0 a 2	0
n03	Seleção de frequência de referência: 0: Consola digital (potenciômetro) 1: Frequência de referência 1 (n21) 2: Terminal do circuito de controlo (0 a 10V) 3: Terminal do circuito de controlo (4 a 20mA) 4: Terminal do circuito de controlo (0 a 20mA) 6: Comunicação (opção)	0 a 4, 6	0
n09	Frequência máxima de saída	50 a 400Hz	
n10	Tensão máxima de saída	1 a 255V (classe de 200V) 1 a 510V (classe de 400V)	200 (classe de 200V) 400 (classe de 400V)
n11	Frequência de saída de tensão máxima	50 a 400Hz	
n16	Tempo de aceleração 1	0,0 a 999 seg	10 seg
n17	Tempo de desaceleração 2	0,0 a 999 seg	10 seg
n21	Frequência de referência 1	0,0 a 400Hz	50Hz
n22 - n28	Frequência de referência 2 - 8	0,0 a 400Hz	0Hz
n32	Corrente nominal do motor	Em função do modelo	0 a 120% da corrente de saída nominal do variador
n36 - n39	Entrada multifunções (S2 -S5)	0 a 35	--
n40	Saída multifunções (MA-MB-MC)	0 a 18	1
n44	Saída analógica multifunções (AM-AC): 0: Frequência de saída (10V/Máx, freq.) 1: Corrente de saída (10V/Corrente nominal do variador)	0,1	0
n46	Frequência portadora	1 a 4 (2,5 - 10kHz) 7 a 9 (Proporcional à freq. de saída)	Em função do modelo
n52	Corrente de frenagem por injeção de CC	0 a 100%	50%
n53	Frenagem por injeção de CC na paragem	0 a 100%	50%
n54	Frenagem por injeção de CC no arranque	0 a 100%	50%
n55	Prevenção contra frenagem durante a desaceleração: 0: Activada 1: Desactivada	0,1	0

Entradas multifunções		Saídas multifunções	
Valor*1	Função	Valor*1	Função
2	Inverso/Paragem	0	Saída de falha
3	Falha externa (NO)	1	Durante o funcionamento
4	Falha externa (NC)	2	Frequência coincidente
5	Reset de falha	6	BMonitorização de sobrebinário (NO)
6	Velocidade de referência multi- step 1	12	Modo RUN

*1 Consulte o manual de utilizador para obter a lista completa

Entradas multifunções		Saídas multifunções	
Valor ^{*1}	Função	Valor ^{*1}	Função
7	Velocidade de referência multi-step 2	13	Variador preparado
8	Velocidade de referência multi-step 3	15	Subtensão em curso
10	Comando por impulsos	Funções de saída analógica	
12	Base block externo (NO)	Valor ^{*1}	Função
13	Base block externo (NC)	0	Frequência de saída
17	Seleção local/remota	1	Corrente de saída

*1 Consulte o manual de utilizador para obter todos os valores das definições

Exemplo de definição de parâmetros

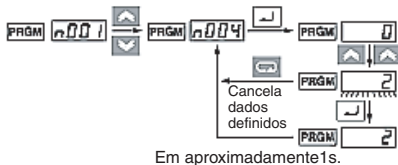

Sequência de teclas	Indicador	Exemplo de visor	Explicação
	PRGM		Ligado
	PRGM		Prima a tecla de modo repetidamente até que o indicador PRGM fique iluminado.
	PRGM		Utilize a tecla de incrementar ou a tecla de decrementar para definir o número do parâmetro.
	PRGM		Prima a tecla Enter. São apresentados os dados do parâmetro seleccionado.
	PRGM		Utilize a tecla de incrementar ou a tecla de decrementar para definir os dados. Nesta altura, o visor começa a piscar.
	PRGM		Prima a tecla Enter para que o valor definido seja introduzido e o visor de apresentação de dados fique iluminado (consulte a nota 1)
Em aproximadamente 1s.	PRGM		O número do parâmetro é apresentado.















Nota 1: Para cancelar o valor definido, prima, em alternativa, a tecla de modo. O número do parâmetro é apresentado.

- 2:** Não é possível alterar determinados parâmetros quando o Variador está em funcionamento. Consulte a lista de parâmetros. Quando tentar alterar estes parâmetros, o visor de apresentação de dados não se altera ao premir na tecla de incrementar ou na tecla de decrementar.

6. Monitores

O VS mini J7 permite monitorizar várias condições, tais como a corrente de saída e o estado das entradas multifunções.

Esta monitorização é efectuada através dos parâmetros “U”.

Sequência de teclas	Indicador	Exemplo de visor	Explicação
			Ligado
			Prima a tecla de modo repetidamente até que o indicador MNTR fique iluminado. É apresentada a informação U01.
			Utilize a tecla de incrementar ou a tecla de decrementar para seleccionar o item a ser apresentado.
			Prima a tecla Enter para que os dados do item seleccionado sejam apresentados.
			O item seleccionado é apresentado novamente ao premir a tecla de modo.

Nº da constante	Nome		Descrição
U01	Frequência de referência (FREF)	Hz	É possível monitorizar a frequência de referência. (Idêntica a FREF)
U02	Frequência de saída (FOUT)	Hz	É possível monitorizar a referência de saída. (Idêntica a FOUT)
U03	Corrente de saída (IOUT)	A	É possível monitorizar a corrente de saída. (Idêntica a IOUT)
U04	Tensão de saída	V	É possível monitorizar a tensão de saída.
U05	Tensão CC	V	É possível monitorizar a tensão CC do circuito principal
U06	Estado do terminal de entrada	--	É possível monitorizar o estado do terminal de entrada dos terminais do circuito de controlo
U07	Estado do terminal de saída	--	É possível monitorizar o estado do terminal de saída dos terminais do circuito de controlo
U09	Histórico de falhas	--	É apresentado o histórico com as últimas quatro falhas
U10	Nº de versão de software	--	É possível verificar o nº de versão de software
U15	Erro de recepção de dados	--	É possível verificar o conteúdo do erro de recepção de dados de comunicação de MEMOBUS. (O conteúdo do registo de transmissão nº 003DH é idêntico)

Estado do terminal de saída/entrada

Estado do terminal de entrada

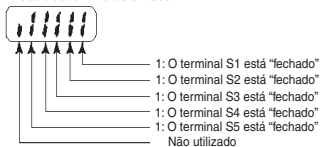

Estado do terminal de saída

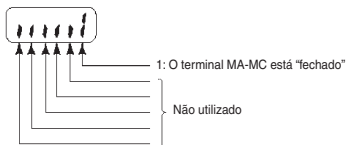

7. Falhas e alarmes

Visor de falhas	Designação e significado da falha	Causa provável e medida a aplicar
OC	Sobrecorrente A saída de corrente é superior a 250% da corrente nominal do variador.	Verifique se ocorreu um curto circuito na saída ou uma falha na ligação à terra. Existe demasiada carga, reduza a mesma ou utilize um Variador mais potente. Verifique a corrente nominal FLA do motor em comparação com a definida no variador e a definição de V/F.
OV	Sobretensão A tensão do bus CC excedeu o nível de detecção.	A inércia da carga é demasiado grande e o motor está em regeneração. Aumente o tempo de desaceleração (n020 ou n022). Ligue uma resistência de frenagem externa e defina n092 para 1. Verifique a resistência de frenagem e a cablagem.
uV1	Subtensão do circuito principal A tensão do bus CC encontra-se abaixo do nível de detecção.	Verifique as ligações e a tensão de alimentação. Verifique se está a ser utilizada a alimentação adequada ao Variador. Efectue a monitorização relativamente a interrupções ou falhas de energia.
OH	Unidade sobreaquecida A temperatura no interior do variador excedeu os 110°C.	Consulte o manual para obter directrizes e recomendações de instalação. Verifique o ventilador (se aplicável). Verifique as características de V/F ou reduza a frequência da portadora.
OL1	Sobrecarga do motor O variador está a proteger o motor contra sobrecarga com base num cálculo IT interno utilizando a definição n036.	Verifique e reduza a carga. Verifique a característica de V/F (V_{max} e F_{max}). Aumente a velocidade de funcionamento do motor. Aumente os tempos de aceleração/desaceleração.
EF ¹	Falha externa Deu entrada uma falha externa.	Verifique a cablagem do terminal de controlo. Foi definida uma entrada digital multifunções para 3 ou 4. É necessário que o sinal de funcionamento seja removido antes do reset desta falha.
SER (a piscar)	Erro de sequência Entrada em sequência com o variador em funcionamento.	É necessário parar o variador quando é tentada a comutação local/remota. É necessário parar o variador quando é tentada a comutação de comunicações/remota.
bb (a piscar)	Base block externo Deu entrada um comando de Base block externo.	Verifique a cablagem do terminal de controlo. Foi definida uma entrada digital multifunções para 12 ou 13.
EF (a piscar)	Ocorreu um erro de sequência	Foi aplicado simultaneamente um sinal de funcionamento directo ou inverso.

*1 Consulte o manual de utilizador para obter listagens de códigos de falhas

VS MINI J7

Инструкция по быстрому запуску

1. Подключение цепей
2. Клеммы схемы управления
3. Монтаж
4. Пробный запуск
5. Список основных параметров
6. Контролируемые параметры
7. Коды неисправностей

1. Подключение цепей

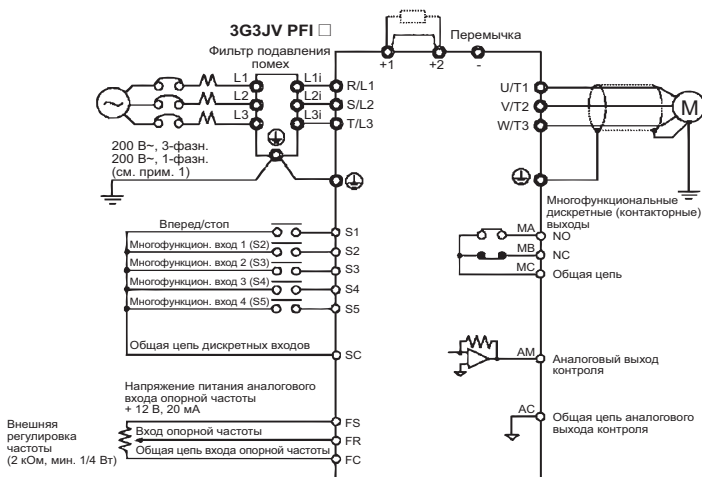

Примечание 1: Однофазное напряжение 200 В~ подается на клеммы R/L1 и S/L2 инвертора J7AZB.

Примечание 2: Тормозной резистор подключить нельзя, поскольку отсутствует тормозной транзистор.

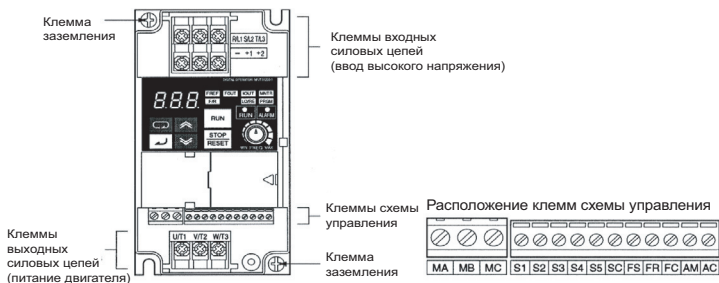

2. Клеммы схемы управления

Обознач.	Название	Функция	Уровень сигнала	
Вход	S1	Вперед/Стоп	ВКЛ: Вперед / ВЫКЛ: Стоп	Оптопара, 8 мА при 24 В ^{*1}
	S2	Многофункциональный вход 1	Определяется параметром п36 (Назад/Стоп) ^{*2}	
	S3	Многофункциональный вход 2	Определяется параметром п37 (Внешняя ошибка: NO) ^{*2}	
	S4	Многофункциональный вход 3	Определяется параметром п38 (Сброс ошибки) ^{*2}	
	S5	Многофункциональный вход 4	Определяется параметром п39 (Вход 1 выбора предустановленной опорной частоты) ^{*2}	
	SC	Общая цепь дискретных входов	Общая цепь дискретных входов S1 ... S5	20 мА при 12 В=
	FS	Напряжение питания входа опорной частоты	Напряжение питания постоянного тока для входа опорной частоты	
	FR	Вход опорной частоты	Аналоговый вход опорной частоты	
FC	Общая цепь входа опорной частоты	Общая цепь входа опорной частоты	4 ... 20 мА 0 ... 20 мА	
Выход	MA	Многофункциональный выход:NO	Определяется параметром п40 (режим RUN) ^{*2}	Релейный выход, макс. 1А при 30 В= и 250 В~
	MB	Многофункциональный выход:NC		
	MC	Общая цепь дискретных выходов	Общая цепь выходов MA и MB	Макс. 12 мА при 0 ... 10 В=
	AM	Аналоговый выход контроля	Определяется параметром п44 (Выходная частота) ^{*2}	
	AC	Общая цепь выхода контроля	Общая цепь выхода AM	

*1 Для этих клемм выбран тип NPN. Внешний источник питания не требуется. Схемы подключения показаны ниже.
 *2 В скобках приведены значения, принимаемые по умолчанию.

Настройка входов

Для выбора способа ввода дискретных сигналов предназначены переключатели SW7 и SW8, расположенные над клеммами схемы управления.

Чтобы получить доступ к этим переключателям, необходимо снять переднюю и дополнительную крышки.

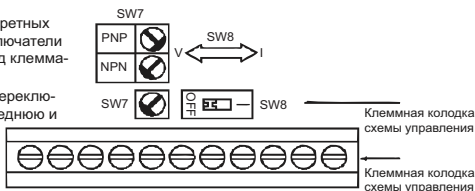

Выбор способа ввода дискретных сигналов

С помощью переключателя SW7 можно выбрать тип дискретных входов (NPN или PNP).

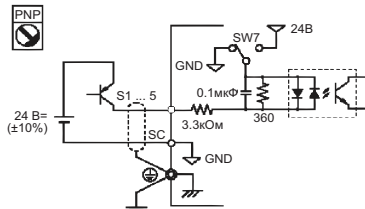
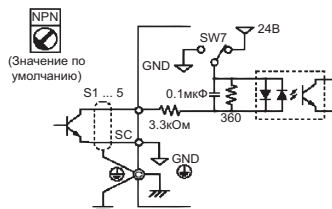

3. Монтаж

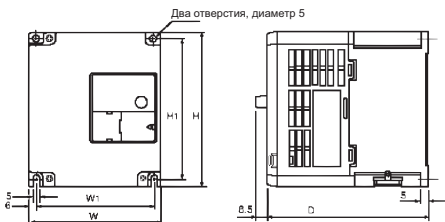

Номинальное напряжение	Модель J7AZ	Размеры (мм)					Рекомендуемые номиналы	
		W	H	D	W1	H1	MCCB (A)	Провод (мм ²)
200 В~ 3-фазное	20P1	68	128	70	56	118	5	2
	20P2	68	128	70	56	118	5	2
	20P4	68	128	102	56	118	5	2
	20P7	68	128	122	56	118	10	2
	21P5	108	128	129	96	118	20	2
	22P2	108	128	154	96	118	20	3.5
200 В~ 1-фазное	24P0	140	128	161	128	118	30	5.5
	B0P1	68	128	70	56	118	5	2
	B0P2	68	128	70	56	118	5	2
	B0P4	68	128	112	56	118	10	2
	B0P7	108	128	129	96	118	20	3.5
	B1P5	108	128	154	96	118	20	5.5
400 В~ 3-фазное	40P2	108	128	81	96	118	5	2
	40P4	108	128	99	96	118	5	2
	40P7	108	128	129	96	118	5	2
	41P5	108	128	154	96	118	10	2
	42P2	108	128	154	96	118	10	2
	43P0	140	128	161	128	118	20	2
44P0	140	128	161	128	118	20	2	

Примечание: MCCB = Автоматический выключатель в литом корпусе.

Технические характеристики фильтра подавления помех

Модель J7AZ	Фильтр 3G3JV-	Размеры					
		W	L	H	Y	X	d
20P1	PFI2010-SE	82	194	50	92	181	5.3
20P2							
20P4							
20P7							
21P5	PFI2020-SE	111	169	50	91	156	5.3
22P2							
24P0	PFI2030-SE	144	174	50	120	161	5.3
B0P1	PFI1010-SE	71	169	45	51	156	5.3
B0P2							
B0P4							
B0P7	PFI1020-SE	111	169	50	91	156	5.3
B1P5							

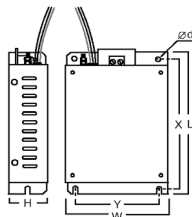

Модель J7AZ	Фильтр 3G3JV-	Размеры					
		W	L	H	Y	X	d
40P2	PF13005-SE	111	169	50	91	156	5.3
40P4							
40P7							
41P5							
42P2	PF13020-SE	144	174	50	120	161	5.3
43P0							
44P0							

Монтаж фильтра подавления помех и инвертора J7

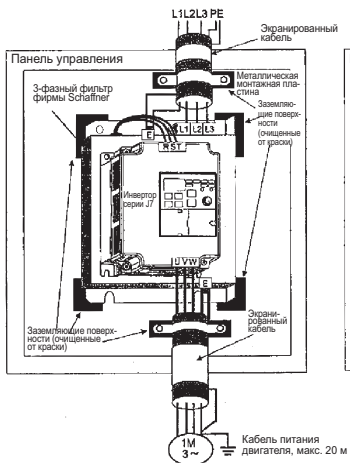

CIMR-J7□□□□20P1 ... 24P0
 CIMR-J7□□□□40P2 ... 44P0

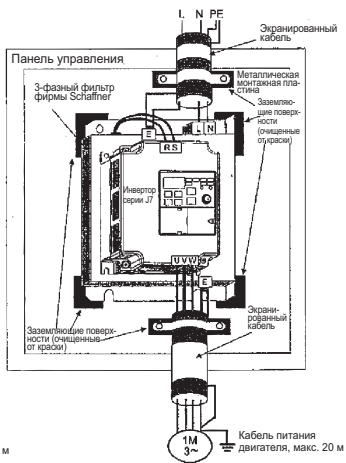

CIMR-J7□□□□B0P1 ... B4P0

Монтажные размеры

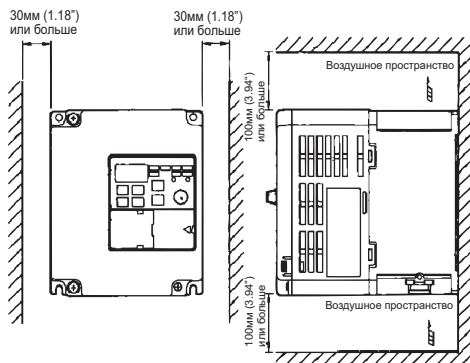

4. Пробный запуск



Внешний вид	Название	Назначение
	Информационный дисплей	Отображение значений соответствующих параметров, например, опорной частоты, выходной частоты и настраиваемых параметров.
	Ручка регулировки FREQ	Настройка значения опорной частоты в диапазоне от 0 Гц до максимального значения частоты.
	Индикатор FREQ	Когда светится этот индикатор, можно контролировать или настраивать опорную частоту.
	Индикатор FOUT	Когда светится этот индикатор, можно контролировать или настраивать выходную частоту инвертора.
	Индикатор IOUT	Когда светится этот индикатор, можно контролировать выходной ток инвертора.
	Индикатор MNTR	Когда светится этот индикатор, контролируются значения, установленные в U01 ... U10.
	Индикатор F/R	Когда светится этот индикатор и инвертор управляется клавишей RUN, можно выбрать направление вращения.

Внешний вид	Название	Назначение
	Индикатор LO/RE	Когда светится этот индикатор, можно выбрать либо управление инвертором с помощью Цифровой панели управления, либо работу инвертора в соответствии с настроенными параметрами. Примечание: Когда инвертор работает в режиме управления двигателем, состояние этого индикатора изменить нельзя. Когда светится этот индикатор, команды, поступающие на вход RUN, игнорируются.
	Индикатор PRGM	Когда светится этот индикатор, можно настраивать или контролировать параметры p01 ... p79. Примечание: Когда инвертор работает в режиме управления двигателем, параметры можно только отображать. Изменять можно только некоторые из них. Когда светится этот индикатор, команды, поступающие на вход RUN, игнорируются.
	Клавиша выбора режима	Последовательный перебор индикаторов настройки и контроля параметров. Если значение, выбранное для параметра, не было подтверждено клавишей "Ввод", и нажата эта клавиша, выбранное значение будет отменено (не вступит в силу).
	Клавиша увеличения значения	Увеличение номера при выборе контролируемого или настраиваемого параметра, а также увеличение значения при настройке параметра.
	Клавиша уменьшения значения	Уменьшение номера при выборе контролируемого или настраиваемого параметра, а также уменьшение значения при настройке параметра.
	Клавиша ввода	Подтверждение (Ввод) номера при выборе контролируемого или настраиваемого параметра, а также подтверждение выбранных или измененных значений.
	Клавиша RUN	Запуск инвертора (двигателя), когда 3G3JV управляется с Цифровой панели управления.
	Клавиша STP/RESET	Прекращение работы инвертора (двигателя), если клавиша не была отключена параметром n06.

Ниже описана процедура оперативного запуска инвертора J7 с целью управления двигателем, подключенным к инвертору по типовой схеме. Процедура состоит из семи шагов:

Шаг 1 – Предварительная проверка

1-1 Проверка перед подачей напряжения питания.

Убедитесь в том, что подается надлежащее напряжение питания.

CIMR-J7AZ2□□□: 200 ... 230 В~, 3-фазное

CIMR-J7AZB□□□: 200 ... 240 В~, 1-фазное (на клеммы R/L1 и S/L2)

CIMR-J7AZ4□□□: 380 ... 460 В~, 3-фазное

1-2 Убедитесь в том, что к выходным силовым клеммам (U/T1, V/T2, W/T3) подключен двигатель.

1-3 Проверьте цепи, подключенные к клеммам схемы управления, и цепи управляющего устройства.

1-4 Убедитесь в том, что на клеммах управления отсутствуют сигналы.

1-5 Переведите двигатель в холостой режим (отсоедините его от нагрузки).

Шаг 2 – Подача напряжения питания и проверка состояния дисплея

- 2-1 Выполните предварительную проверку (Шаг 1), подайте на входные силовые клеммы напряжение питания.
- 2-2 В нормальном режиме при поданном напряжении дисплей выглядит следующим образом:
- индикатор RUN: мигает
 - индикатор ALARM: выключен
 - индикаторы настройки/контроля: светится индикатор FREF, FOUT или IOUT
 - информационный дисплей: отображает информацию, соответствующую светящемуся индикатору.

В случае возникновения неисправностей отображается соответствующая информация о неисправности. В этом случае следует воспользоваться руководством по эксплуатации и принять необходимые меры.

Шаг 3 – Инициализация параметров

Чтобы инициализировать параметры привода (вернуть заводские значения), следует выбрать параметр n01 = 8. В результате инвертор J7 перейдет в так называемый "2-проводный" режим управления. В этом режиме для подачи команд "Ход"/"Стоп" используются два сигнала (два провода): один сигнал - команда "Вперед"/"Стоп", один сигнал - команда "Назад"/"Стоп".







Нажимаемые клавиши	Индикатор	Пример дисплея	Пояснение
			Включение питания.
			Нажмите клавишу "Режим" несколько раз, пока не начнет светиться индикатор PRGM.
			Нажмите клавишу "Ввод". На дисплее отобразится значение параметра n01.
			С помощью клавиш увеличения/уменьшения выберите для n01 значение 8. Дисплей будет мигать.
			Нажмите клавишу "Ввод", чтобы подтвердить установленное значение, дисплей перестанет мигать.
Приблиз. через 1 с			На дисплее будет отображаться номер параметра.

Шаг 4 – Задайте номинальный ток двигателя

Этот параметр используется функцией электронной тепловой защиты и предназначен для обнаружения перегрузки двигателя (OL1). Если этот параметр задан правильно, инвертор J7 предотвратит перегорание двигателя в случае его перегрузки.

Введите в параметр n32 значение номинального тока (в амперах), указанное на паспортной табличке двигателя. Ниже показан пример ввода значения 1.8 А.

Нажимаемые клавиши	Индикатор	Пример дисплея	Пояснение
			Отображается номер параметра.
			С помощью клавиш увеличения/уменьшения выберите параметр n32.

Нажимаемые клавиши	Индикатор	Пример дисплея	Пояснение
	PRGM		Нажмите клавишу "Ввод". На дисплее отобразится значение параметра p32.
	PRGM		С помощью клавиш увеличения/уменьшения задайте номинальный ток двигателя. Дисплей будет мигать.
	PRGM		Нажмите клавишу "Ввод", чтобы подтвердить установленное значение, дисплей перестанет мигать.
Приблиз. через 1 с	PRGM		На дисплее будет отображаться номер параметра.

Шаг 5 – Задайте номинальную частоту двигателя

Номинальная частота - это максимальная частота, при которой может работать двигатель. Это значение позволяет инвертору J7 корректно управлять двигателем. Введите в параметры p09 и p11 значение номинальной частоты (в Гц), указанное на паспортной табличке двигателя.

Шаг 6 – Задайте способ подачи команд

Выберите способ подачи команд на запуск и останов двигателя (т.е., как инвертор будет запускать и останавливать двигатель). Предусмотрено два основных способа управления: с помощью клавиш RUN и STOP/RESET на цифровой панели управления, либо с помощью одного из многофункциональных входов, т.е., путем подачи сигнала на одну из клемм схемы управления.

Чтобы выбрать способ подачи команд, следует ввести соответствующее значение в параметр p02:

0 = используются клавиши RUN и STOP/RESET на Цифровой панели управления.

1 = многофункциональные входы (клеммы схемы управления).

Ниже показана схема подключения переключателя для подачи команд "Ход"/"Стоп" (двигатель вращается в прямом направлении) по схеме "2-проводного" управления. Установите параметр p02=1. Чтобы предусмотреть отдельный переключатель для подачи команды "Ход назад" (на клемме S2), установите параметр p36=2 (это его значение по умолчанию).

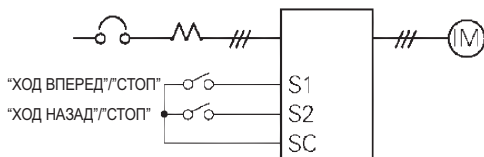

Шаг 7 – Задайте способ ввода опорной частоты

Выберите способ ввода задания скорости двигателя. По умолчанию выбрано использование потенциометра на Цифровой панели управления (ручка регулировки FREF). В этом случае настройку производить не требуется.

Для ввода значения опорной частоты также можно использовать внешний потенциометр или сигнал аналогового выхода ПЛК. Кроме того, можно предустановить 8 фиксированных значений скорости (опорной частоты) и выбирать их с помощью многофункциональных входов.

Например, чтобы использовать для ввода опорной частоты внешний потенциометр либо аналоговый сигнал 0...10В от ПЛК, установите параметр p03=2.

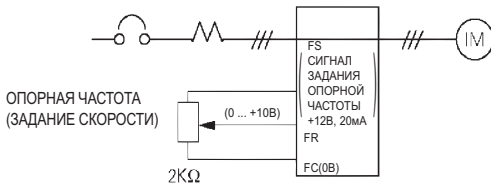

5. Список основных параметров*1

Номер параметра	Описание	Диапазон значений	Значение по умолчанию
p01	Доступ к параметрам: 0: Ограниченный доступ к параметрам 1: Полный доступ к параметрам 8: Инициализация параметров (возврат к заводским значениям)	0 ... 9	1
p02	Выбор способа подачи команды "Ход": 0: Цифровая панель управления 1: Клеммы схемы управления 2: Коммуникационный интерфейс (опция)	0 ... 2	0
p03	Выбор способа задания опорной частоты: 0: Цифровая панель управления (потенциометр) 1: Опорная частота 1 (n21) 2: Клемма схемы управления (0 ... 10В) 3: Клемма схемы управления (4 ... 20мА) 4: Клемма схемы управления (0 ... 20мА) 6: Коммуникационный интерфейс (опция)	0 ... 4, 6	0
p09	Максимальная выходная частота	50 ... 400Гц	
p10	Максимальное выходное напряжение	1 ... 255В (класс 200В) 1 ... 510В (класс 400В)	200 (класс 200В) 400 (класс 400В)
N11	Максимальная частота выходного напряжения	50 ... 400Гц	
p16	Время разгона 1	0.0 ... 999 сек	10 сек
p17	Время торможения 2	0.0 ... 999 сек	10 сек
n21	Опорная частота 1	0.0 ... 400Гц	50Гц
p22 - p28	Опорная частота 2 - 8	0.0 ... 400Гц	0Гц
p32	Номинальный ток двигателя	Зависит от модели	0 ... 120% от номинального выходного тока инвертора
p36 - p39	Многофункциональный вход (S2 -S5)	0 ... 35	--
p40	Многофункциональный выход (MA-MB-MC)	0 ... 18	1
p44	Многофункциональный аналоговый выход (AM-AC): 0: Выходная частота (10В/макс. частота) 1: Выходной ток (10В/Номинальный ток инвертора)	0,1	0

*1 Полный список приведен в Руководстве по эксплуатации

Номер параметра	Описание	Диапазон значений	Значение по умолчанию
p46	Несущая частота	1 ... 4 (2.5 - 10 кгц) 7 ... 9 (пропорционально выходной частоте)	Зависит от модели
p52	Ток при торможении с подпиткой постоянным током	0 ... 100%	50%
p53	Продолжительность торможения с подпиткой постоянным током при останове	0.0 ... 25.5 сек	0.5 сек
p54	Продолжительность торможения с подпиткой постоянным током при запуске	0.0 ... 25.5 сек	0.0 сек
p55	Предотвращение опрокидывания ротора при торможении: 0: Разрешено 1: Отключено	0,1	0

Многофункциональные входы		Многофункциональные выходы	
Значение ^{*1}	Функция	Значение ^{*1}	Функция
2	Вперед/Стоп	0	Выход "Ошибка"
3	Внешняя ошибка (нормально-разомкнутая цепь)	1	Выход "Run"
4	Внешняя ошибка (нормально-замкнутая цепь)	2	Согласование частот
5	Сброс ошибки	6	Обнаружение превышения момента (нормально-разомкнутый контакт)
6	Команда 1 выбора предустановленной скорости (частоты)	12	Режим RUN
7	Команда 2 выбора предустановленной скорости (частоты)	13	Готовность инвертора
8	Команда 3 выбора предустановленной скорости (частоты)	15	Пониженное напряжение
10	Команда "Толчковый ход"	Функции аналоговых выходов	
12	Внешний сигнал блокировки выхода (нормально-разомкнутая цепь)	Значение^{*1}	Функция
13	Внешний сигнал блокировки выхода (нормально-замкнутая цепь)	0	Выходная частота
17	Выбор локального/дистанционного управления	1	Выходной ток

*1 Полный список приведен в Руководстве по эксплуатации

Пример настройки параметра



Нажимаемые клавиши	Индикатор	Пример дисплея	Пояснение
	PRGM	00	Включение питания.
	PRGM	n01	Нажмите клавишу "Режим" несколько раз, пока не начнет светиться индикатор PRGM.
	PRGM	n03	С помощью клавиш увеличения/уменьшения выберите требуемый параметр.
	PRGM	0	Нажмите клавишу "Ввод". Будет отображено значение выбранного параметра.
	PRGM	2	С помощью клавиш увеличения/уменьшения установите требуемое значение. Дисплей при этом будет мигать.
	PRGM	2	Нажмите клавишу "Ввод", чтобы подтвердить выбранное значение. Индикатор перестанет мигать (см. прим. 1)
Приблиз. через 1 с	PRGM	n03	Будет отображен номер параметра.

Примечание 1: Чтобы отменить введенное значение, нажмите вместо клавиши "Ввод" клавишу "Режим". Будет отображен номер параметра.

2: Некоторые параметры нельзя изменить, когда инвертор находится в режиме управления двигателем (см. список параметров). При попытке изменения таких параметров значение, отображаемое на дисплее, не изменяется при нажатии клавиш увеличения/уменьшения.

6. Контролируемые параметры

В инверторе Vs mini J7 предусмотрена возможность контроля различных параметров, например, выходного тока или состояния многофункциональных входов.

Для контроля различных параметров предназначены параметры группы "U".

Нажимаемые клавиши	Индикатор	Пример дисплея	Пояснение
			Включение питания
			Нажмите несколько раз клавишу "Режим", пока не будет светиться индикатор MNTR. Будет отображен параметр U01.
			С помощью клавиш увеличения/уменьшения выберите контролируемый параметр, который должен быть отображен.
			Нажмите клавишу "Ввод", чтобы отображился выбранный контролируемый параметр.
			После нажатия клавиши "Режим" вновь будет отображен номер контролируемого параметра.

Номер параметра	Название		Описание
U01	Опорная частота (FREF)	Гц	Контроль значения опорной частоты (как и при использовании FREF)
U02	Выходная частота (FOUT)	Гц	Контроль значения выходной частоты (как и при использовании FOUT)
U03	Выходной ток (IOUT)	А	Контроль значения выходного тока (как и при использовании IOUT)
U04	Выходное напряжение	В	Контроль значения выходного напряжения
U05	Напряжение постоянного тока	В	Контроль высокого (силового) напряжения постоянного тока
U06	Состояние входных клемм	--	Можно контролировать состояние (уровень сигнала) на входных клеммах схемы управления
U07	Состояние выходных клемм	--	Можно контролировать состояние (уровень сигнала) на выходных клеммах схемы управления
U09	Журнал ошибок	--	Можно отобразить четыре последних ошибки
U10	Версия (номер) программы	--	Можно отобразить номер версии программного обеспечения
U15	Ошибка приема данных	--	Можно отобразить содержание ошибки приема данных через интерфейс связи MEMOBUS (совпадает с содержимым передающего регистра 003DH)

Состояние входных/выходных клемм

Состояние входных клемм

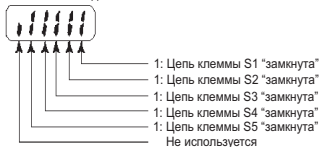

Состояние выходных клемм

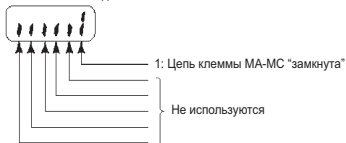

7. Коды неисправностей

Код неисправности	Описание неисправности (ошибки)	Возможная причина и способ устранения
OC	Перегрузка по току Выходной ток превышает 250% от номинального тока инвертора.	Короткое замыкание или замыкание на землю на выходе. Устраните. Слишком большая нагрузка. Уменьшите нагрузку или используйте более мощный инвертор. Проверьте, соответствует ли номинальный ток двигателя инвертору, и правильно ли он указан в соответствующем параметре инвертора.
OV	Повышенное напряжение Превышен допустимый уровень напряжения в шине постоянного тока (уровень обнаружения повышенного напряжения).	Слишком инерционная нагрузка, двигатель входит в режим регенерации. Увеличьте время торможения (p020 или p022). Подсоедините внешний тормозной резистор и выберите p092 = 1. Проверьте тормозной резистор и его цепи.
uV1	Пониженное напряжение в силовой цепи Напряжение в шине постоянного тока ниже допустимого уровня (уровня обнаружения пониженного напряжения).	Проверьте напряжение питания и входные силовые цепи. Проверьте, соответствует ли напряжение питания инвертора требованиям технической документации. Убедитесь в отсутствии провалов или прерываний в сетевом напряжении.
OH	Перегрев модуля Температура внутри инвертора превышает 110°C.	Ознакомьтесь с указаниями и рекомендациями по монтажу в Руководстве по эксплуатации. Проверьте охлаждающий вентилятор (если он установлен). Проверьте V/F характеристику и уменьшите несущую частоту.
OL1	Двигатель перегружен Инвертор защищает двигатель от перегрузки, используя для внутреннего расчета IT значение параметра p036.	Проверьте и снизьте нагрузку. Проверьте V/F характеристику (V_{max} и F_{max}). Увеличьте рабочую частоту вращения двигателя. Повысьте время разгона/время торможения.

Код неисправности	Описание неисправности (ошибки)	Возможная причина и способ устранения
EF ¹	Внешняя ошибка Подан сигнал внешней ошибки.	Проверьте цепи клемм схемы управления. Для многофункционального дискретного входа выбрана функция 3 или 4. Эту ошибку можно сбросить только после снятия сигнала "Ход" (Run).
SER (мигает)	Ошибка команды дискретного входа На дискретный вход подана команда при работающем инверторе.	При переключении локального/дистанционного режима, инвертор должен быть остановлен. При переключении "Коммуникационный интерфейс"/ "Дистанционное управление" инвертор должен быть остановлен.
bb (мигает)	Внешняя команда блокировки выхода Подана внешняя команда блокировки выхода.	Проверьте цепи клемм схемы управления. Для многофункционального дискретного входа выбрана функция 12 или 13.
EF (мигает)	Ошибка управления	Одновременно поданы сигналы "Ход вперед" и "Ход назад".

*1 Полный список кодов ошибок содержится в Руководстве по эксплуатации

OMRON EUROPE B.V. Wegalaan 67-69, NL-2132 JD, Hoofddorp, The Netherlands.
Tel: +31 (0) 23 568 13 00 Fax: +31 (0) 23 568 13 88 www.europe.omron.com

Austria

Tel: +43 (0) 1 80 19 00
www.omron.at

Belgium

Tel: +32 (0) 2 466 24 80
www.omron.be

Czech Republic

Tel: +420 234 602 602
www.omron.cz

Denmark

Tel: +45 43 44 00 11
www.omron.dk

Finland

Tel: +358 (0) 9 549 58 00
www.omron.fi

France

 0 825 825 679
www.omron.fr

Germany

Tel: +49 (0) 2173 680 00
www.omron.de

Hungary

Tel: +36 (0) 1 399 30 50
www.omron.hu

Italy

Tel: +39 02 32 681
www.omron.it

Netherlands

Tel: +31 (0) 23 568 11 00
www.omron.nl

Norway

Tel: +47 (0) 22 65 75 00
www.omron.no

Poland

Tel: +48 (0) 22 645 78 60
www.omron.com.pl

Portugal

Tel: +351 21 942 94 00
www.omron.pt

Russia

Tel: +7 095 745 26 64
www.omron.ru

Spain

Tel: +34 913 777 900
www.omron.es

Sweden

Tel: +46 (0) 8 632 35 00
www.omron.se

Switzerland

Tel: +41 (0) 41 748 13 13
www.omron.ch

Turkey

Tel: +90 (0) 216 474 00 40 Pbx
www.omron.com.tr

United Kingdom

Tel: +44 (0) 870 752 08 61
www.omron.co.uk

For the Middle East, Africa and other countries in Eastern Europe, Tel: +31 (0) 23 568 13 00 www.europe.omron.com

Manufacturer



YASKAWA ELECTRONIC CORPORATION

YASKAWA

In the event that the end user of this product is to be the military and said product is to be employed in any weapons systems or the manufacture thereof, the export will fall under the relevant regulations as stipulated in the Foreign Exchange and Foreign Trade Regulations. Therefore, be sure to follow all procedures and submit all relevant documentation according to any and all rules, regulations and laws may apply. Specifications are subject to change without notice for ongoing product modifications and improvements.

© 2003 OMRON Yaskawa Motion Control. All rights reserved.

Note: Specifications subject to change without notice.
Manual No. 139E-EN-01

